

# HULL

## RESIDENTIAL DESIGN GUIDE

---



Intentionally left blank

### **Credits**

---

This document has been prepared by Hull City Councils Planning and Urban Design team in association with Harper Perry Architects.

All photography copyright remains with the credited photographer and are not for distribution, reproduction or sale.

All illustrations remain the copyright of Harper Perry Ltd and Hull City Council and are not for distribution, reproduction or sale.



---

Baltic 39,  
31-39 High Bridge,  
Newcastle Upon Tyne,  
NE1 1EW

# Contents

## **1. Introduction**

---

- 1.1 Purpose of SPD
- 1.2 Policy context
- 1.3 Building for Life 12
- 1.4 Pre-application engagement
- 1.5 Design guidance in this SPD
- 1.6 Investing and protecting design quality

## **2. Urban Design Principles**

---

- 2.1 Existing network
- 2.2 Well-connected layouts
- 2.3 Grids and blocks
- 2.4 Cul-de-sacs
- 2.5 Density and form
- 2.6 Appreciating scale
- 2.7 Context and character
- 2.8 Views and landmarks
- 2.9 Enclosure
- 2.10 Corners
- 2.11 Townscape materials
- 2.12 Working with the landscape
- 2.13 Trees and street trees
- 2.14 Making space for planting
- 2.15 Sustainable drainage
- 2.16 Boundary treatments

## **3. Designing Streets and Public Space**

---

- 3.1 Streets not roads
- 3.2 Animated street fronts
- 3.3 Equitable places
- 3.4 Addressing flood risk and achieving access for all

- 3.5 Surface materials and crossing points
- 3.6 Positive public spaces
- 3.7 Residential street types
- 3.8 Street geometry
- 3.9 Integrating car parking
- 3.10 Parking design principles
- 3.11 Cycle parking
- 3.12 Recycling and bin storage

## **4. Building Design**

---

- 4.1 Design approaches
- 4.2 Façades
- 4.3 Window design
- 4.4 Infilling
- 4.5 Tall buildings
- 4.6 Materials quality
- 4.7 Detailing
- 4.8 Fabric first
- 4.9 Resilience
- 4.10 Smarter homes
- 4.11 Modular housing
- 4.12 Daylight and sunlight
- 4.13 Thresholds
- 4.14 Private amenity space
- 4.15 Space around homes
- 4.16 Houses in multiple occupation

## **5. References**

---

- 5.1 References and further reading
- 5.2 Figures

Intentionally left blank

## 1.0 Introduction

### Purpose of SPD

---

This document outlines the process, considerations, qualities, and opportunities that will help to deliver high quality residential development in Hull. This guidance is not drafted as a substitution for design talent and does not intend to impose any particular tastes. Essentially this guidance is about promoting processes that lead to good design practice and proposals. It aims to give a clear understanding of the design approaches to all elements of residential design that is likely to be deemed acceptable.

This Supplementary Planning Document (SPD) supplements policies in the Hull Local Plan 2016 to 2032. It provides additional planning guidance most directly related to Policy 14 Design and Policy 21 Designing for housing. The SPD provides guidance that in some cases is directly or indirectly relevant to other Local Plan policies. This is because residential development affects many areas of planning policy including, but not restricted to: type and mix of housing (Policy 5); housing space standards (Policy 6); Houses in multiple occupation (Policy 7) local distinctiveness (Policy 15); heritage assets (Policy 16); renewable and low carbon energy (Policy 18); parking (Policy 32); drainage and flood risk (Policies 39 and 40); open space (Policy 42); green infrastructure, biodiversity, wildlife and trees (Policies 43, 44 and 45). Where this is the case this SPD is compatible with the respective policy position and builds on this from the perspective of residential development. This SPD contains references to other planning policy guidance documents.

Building for Life 12 (BfL12) is intended to be used as a design dialogue tool, with 12 simple, easy to understand questions to help think through the design of residential developments. It is most effective when used as a basis for discussion at the beginning of, and throughout the pre-application process. It is embedded within Local Plan Policy 21 as a way of supporting planning applications. Table 1 below provides references which link the SPD guidance to both BfL12 and the National Planning Policy Framework (NPPF).

## Pre-application engagement

National Planning Policy Framework promotes early engagement and front-loading as having significant potential to improve the efficiency and effectiveness of the planning application system for all parties. Good quality pre-application discussion should cover design and is an opportunity to discuss this guidance SPD.

SPD Guidance	NPPF chapter	BfL12 Question	Local Plan Policy
2. Urban Design Principles	7/8/9/11/12/14/15	1/2/3/5/6/7/8	14/15/16/21/26/38/39/ 40/43/44/45
3. Designing Streets and Public Space	9/12/14	5/7/8/9/10/11/ 12	14/15/16/21/32/36/40
4. Building Design	12/14/15/16	4/5/6/7/11/12	5/6/14/16/17/18/21/ 38/39

Table 1: Illustrates the relationship between the guidance and the NPPF, BfL12, and Hull Local Plan.

## Design Guidance in this SPD

Design includes functional aspects (how it works) and aesthetic properties (how it will look and relate). Successful residential design will be able to demonstrate both.

Hull City Council has developed a strong policy framework to enable it to appraise development proposals in design terms, and provide developers and their design teams with a clear understanding of how to go about developing a design approach which is likely to be deemed acceptable. In this way this SPD aims to help speed up the planning process and improve the quality of residential development in Hull.

All the content within this design guide is given with the best intention of assisting developers and their design teams. It is given in the full knowledge that it may not always be possible for every design proposal to follow every aspect to the letter. In this sense it stands to be challenged where a better design approach can be fully justified. Guidance is generally given from the perspective of proposals for new build residential development but it is also applicable to conversions of buildings into residential uses, and Houses in Multiple Occupancy (HMOs).

The term 'design team' is used throughout this guidance to address a wide range of stakeholders with an interest and influence in the design of residential development.



## Investing and protecting design quality

Investment in design skills and quality has significant potential to improve the efficiency and effectiveness of the planning system. Many of the problems encountered at planning which hold up proposals, or lead to them being refused, can be resolved through design solutions, and/or avoided altogether with upfront investment in design skills.

Experience has shown that following a robust design process is sometimes not enough to ensure a design is not then

simplified after permission has been granted. In new residential development it is important that an appropriate level of design detail and resolution is submitted as part of plans and drawings, and this detail is recorded in planning consents to safeguard the quality of design post-approval. This could, and will often, include specific conditions and a requirement for larger-scale drawings, samples of materials, and detailed records of existing features.

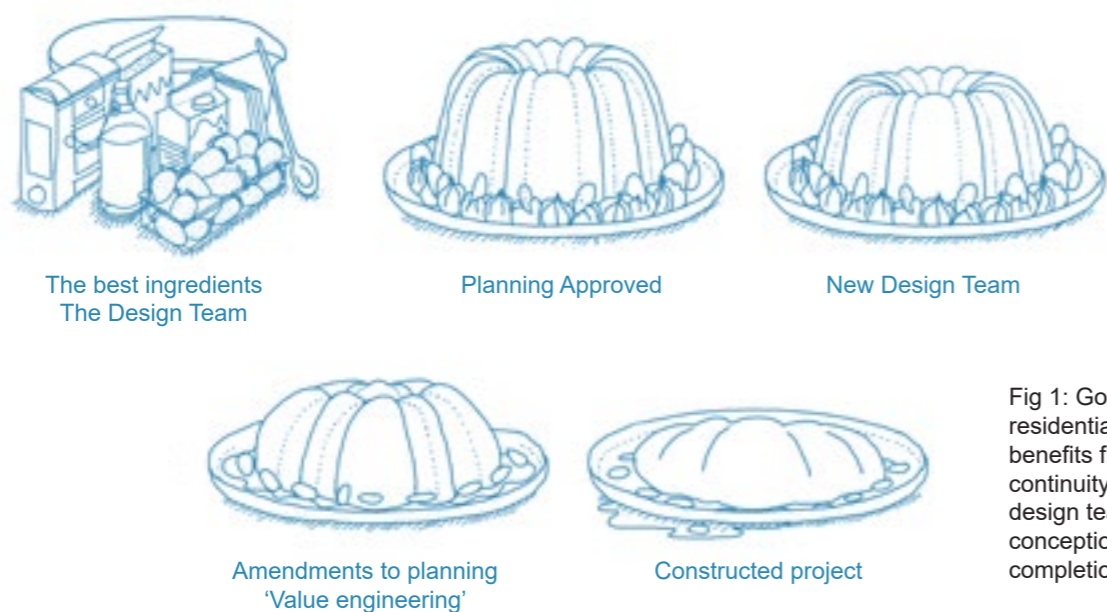

Fig 1: Good residential design benefits from continuity in the design team from conception to completion.

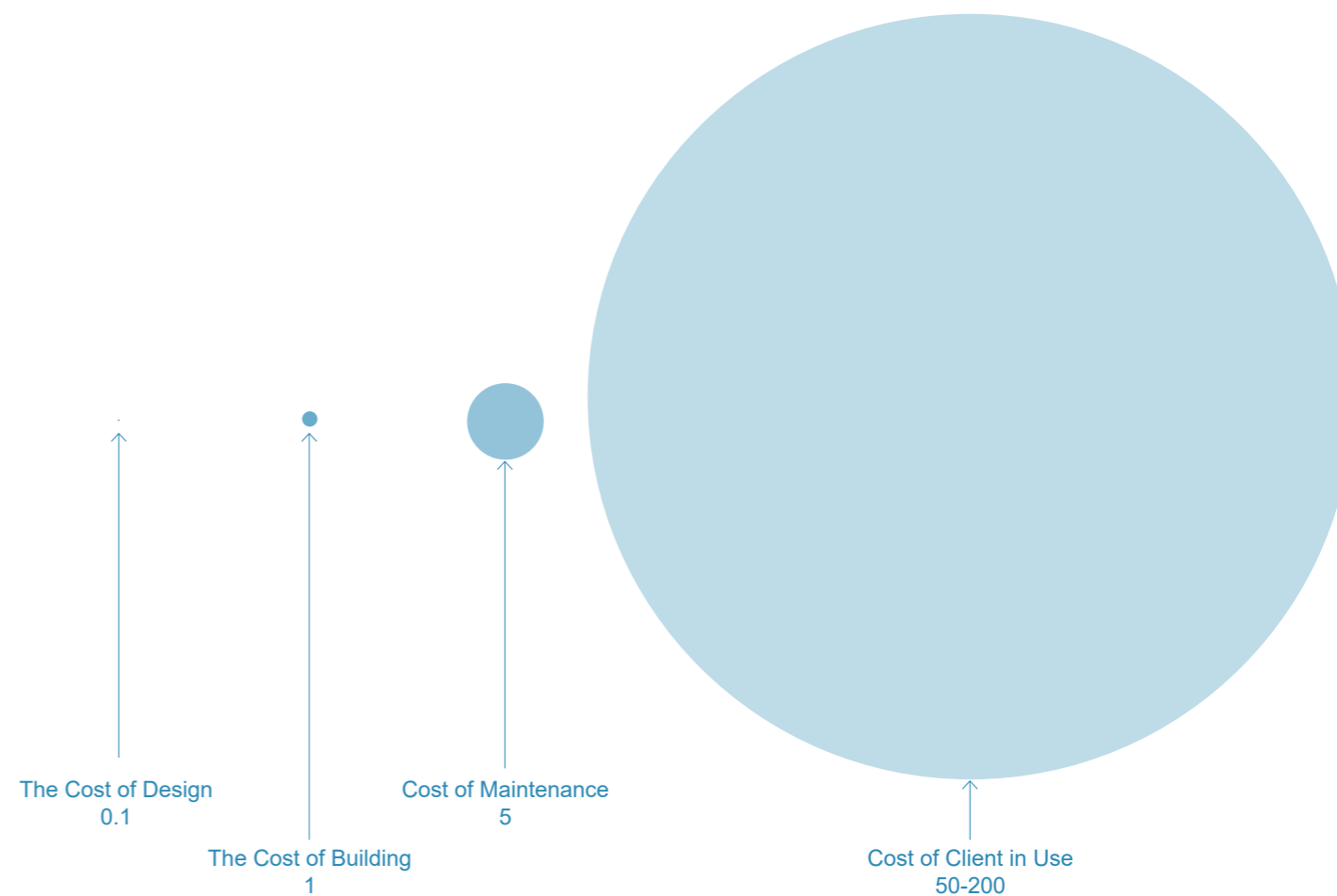

Fig 2: The impact of design on life cost. Small gains in reducing the cost of design team and capital construction cost are a false economy when considered against the cost of maintenance and client in use. Investment in design should be considered as a significantly higher saving for the investor and end user over the lifespan of a new building. Source: Professor John Cole, The Implications of the Cole Report.

## Urban Design Principles



Fig 3. Humber Street, Fruit Market, Hull



## Existing network

In any development proposal large enough to be creating new routes, it makes good design sense for new routes to connect up to as many access points as possible outside the site itself.

Early in the design process design teams should make an assessment of routes in the surrounding area and decide which links are most important to extend into the site, and the most

appropriate access points onto the site. Design teams should consider where future occupants are likely to want to go i.e. local schools, local shops, or nearest bus stop. New development must connect with these places with a choice of convenient, safe routes.

## Well-connected layouts

Layout is the way in which buildings, streets and other open spaces are arranged in relation to each other and their surroundings. It is one of the most important factors in determining the success of new development.

Traditional, compact and walkable layouts are preferred to dispersed car-dependent layouts. Residential developments should avoid internalised layouts that turn their back to their surroundings and congregate around dead ends. On sites where it is possible to have multiple routes in and out, proposals based on a single point of access will not be supported.

A good test to apply to any residential layout is to plot a child's route from home to school from various parts of the development, ensuring a choice of convenient, safe routes that follow desire lines and encourage walking.

Another important consideration is the need to create environments that are secure and enable residents to live without the fear of crime.

Fig 4. Well-connected layouts come from detailed analysis of the site and surrounding streets. Proposals should demonstrate how strategies for integrating street networks, open spaces, commercial elements, pedestrian movement, parking and gardens have been considered in setting out clearly defined residential layouts.

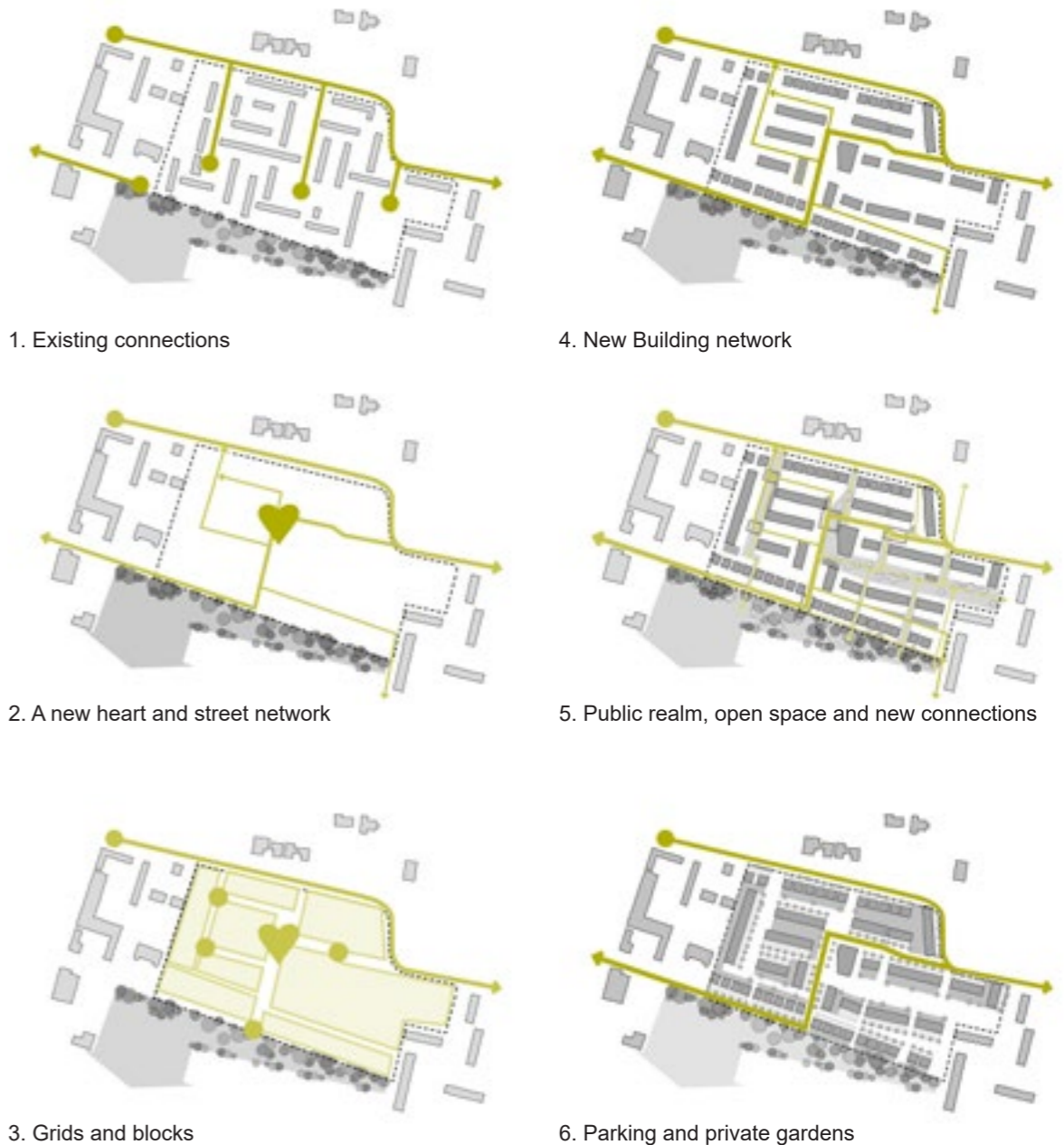

## Grids and blocks

Whether regular or irregular, grid structures are an efficient way of using space, maximising connections between places, offering opportunities for different routes and encouraging walking and cycling. Street-focused layouts favour grids made up of perimeter blocks with buildings which front onto the street and private spaces at the back.

A perimeter block is a group of buildings surrounded on all sides by public space (normally streets) which in turn are defined by the public fronts of the buildings. In the majority of cases proposing a structure based on perimeter blocks will put schemes on course to achieving many of the good design principles required for new residential developments in Hull.

Whether blocks are formal (square or rectangular) or informal (irregular with more variety of angles) will depend largely on the site and local characteristics. Perimeter blocks can consist of houses, flats and other compatible uses and will accommodate a range of building types and densities.

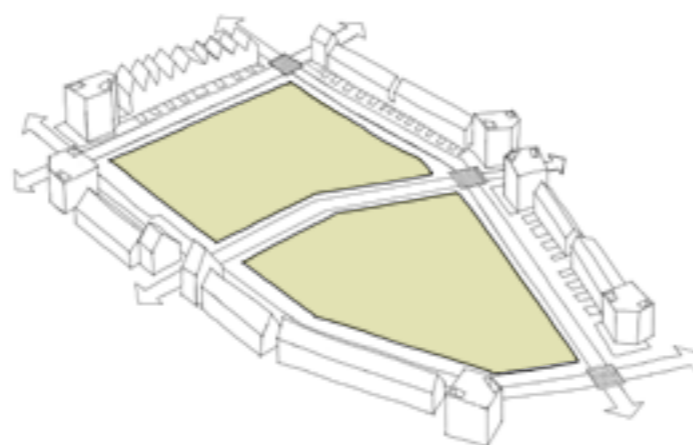

1. Perimeter blocks defined

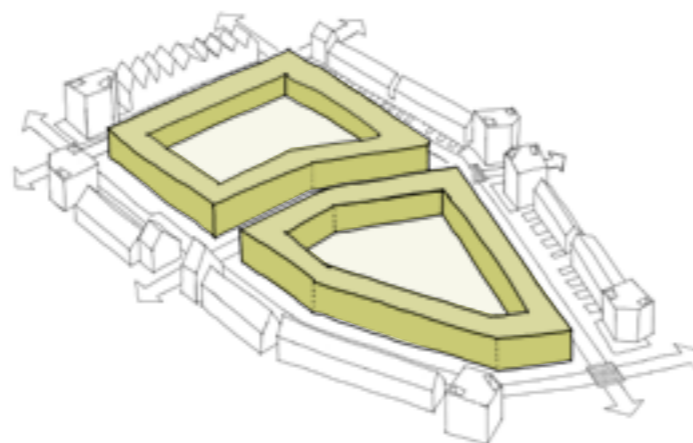

2. Perimeter blocks given mass

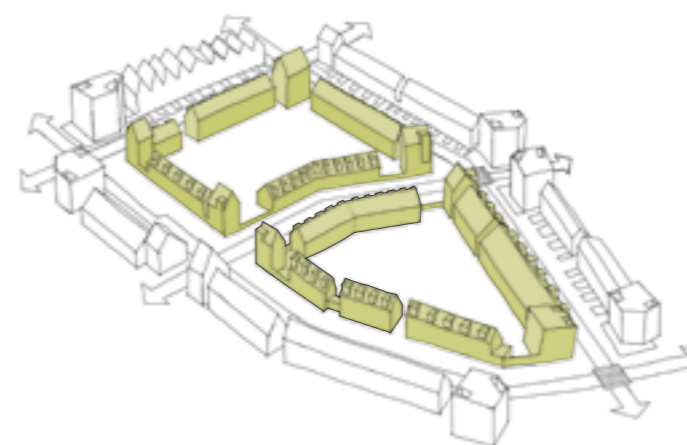

3. Perimeter blocks divided into terraces and articulated at corners

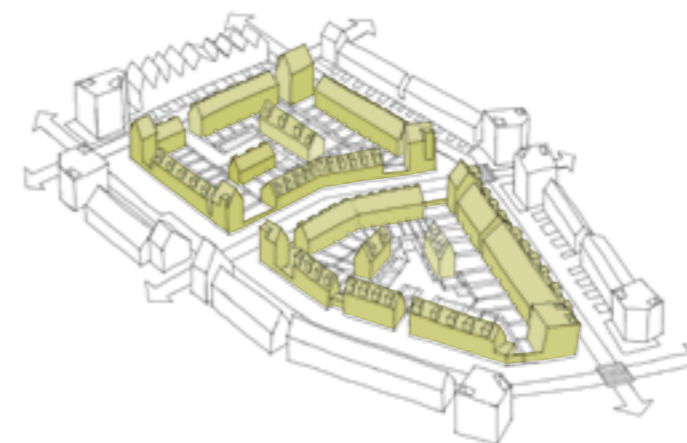

4. Definition of private gardens, off-street parking and inner perimeter housing to provide activity, overlooking and security.

Fig 5. Strategic site plans should analyse the basic layers required for new residential layouts with a preference towards the uniformity of grids and blocks. These can be loosened up with courtyards or mews streets that activate the spaces at the centre of blocks.



Fig 6: 'Cul de sac' developments work best on a small scale and where they provide vehicle and pedestrian connections to existing neighbourhoods. Perimeter blocks can be activated through unique house types at the centre to provide activation of these inner spaces.

## Cul-de-sacs

Cul-de-sacs are often popular with the people who live in them as they prevent through traffic and create the sense of a private 'gated community'. However, cul-de-sacs undermine attempts to develop a well-connected network of streets because they create a series of dead-ends which make it very difficult to continue the development of the city in a well-connected way.

Layouts largely based on cul-de-sacs are not appropriate. Sometimes they may be required because of site constraints, or existing boundaries which don't allow for through routes.

Cul-de-sacs which punctuate a development block within an otherwise connected grid is an acceptable use which makes the most of available space. A good example of cul-de-sacs (or inner perimeter housing) designed this way is the Derwenthorpe development in York. The Riley Way housing development in Hull utilises a similarly good design principles, but is executed less well with parking dominated courtyards.



## Density and form

An assessment of what is an appropriate density and form of development must take into consideration local context. As a rule of thumb the density of proposed developments should be an appropriate response to the character of the surrounding area. Densities between 30-40 dwellings per hectare (dph) are often regarded as being able to achieve a critical mass of residents able to support neighbourhood services such as public transport, local shops, schools and health services.

This is not a rigid target and higher density developments can be achieved in well-connected areas of the city in walking distance of neighbourhood

centres and public transport nodes, and in walking or cycling distance of employment areas.

Hull city centre will be a significant focus for residential development, reflecting Local Plan policy and the popularity and demand for new homes in this accessible location means higher densities are appropriate.

Densities need not be uniform across a scheme. Variations in building type should give different local densities. Perimeter blocks are a favoured form of development as they can accommodate a diversity of building types and densities as shown in figure 7.

Fig 7: Scale and density should come from an understanding of the surrounding context. Larger developments should vary in scale to create local landmarks and frame views.

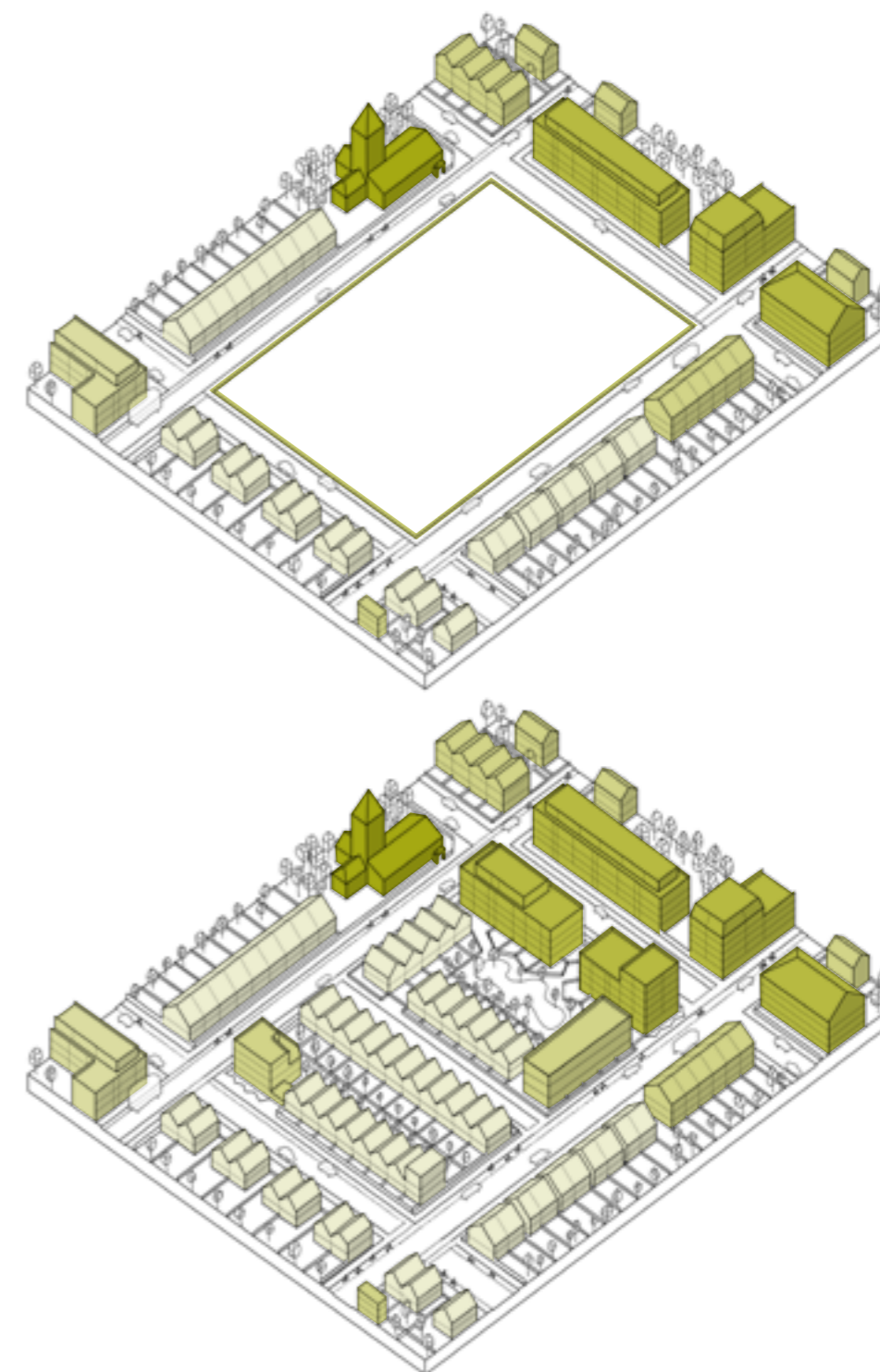



## Appreciating scale

Here the guidance considers how different building heights and massing within a proposed development will relate to one another and their impact on the quality of the spaces immediately around them.

New residential development should take cues in scale from the surrounding context and respect hierarchies in scale where appropriate.

The manner and extent to which local context is used to influence the scale of new development largely depends on the amount of the development proposed. A large residential scheme may be able to create a place within a place with an essentially independent character. The need to respect local context becomes more important towards the edges of a development where the emphasis is on integrating with the surrounding urban form.

Appreciating scale is more than adopting a scale of development that fits with the site and its context. Scale is also a tool designers are expected to use to create attractive places by making them more legible, by creating a strong sense of enclosure around public spaces, and introducing variations and landmarks.

Mono-scaled developments will result in dull uninteresting places. Varying heights and massing throughout a development will increase architectural interest, influence light and shadow, determine vistas and shape the microclimate.

Appreciating scale is different from copying scale. For example, a development site may contain an existing building that is to be retained for its heritage value. To simply copy the scale of this building may detract from it. But to vary the scale of new development may reinforce the original building's impact.

When designing residential developments an important consideration will be how the development will be experienced at human scale. Developers and their design teams will be expected to demonstrate how the massing and scale of proposals have been considered in terms of how the neighbourhood, block and street are viewed and experienced on foot.

Fig 8: Scale should come from an understanding of the surrounding development. Suburban development can vary in scale to create local landmarks and frame views



Fig 9: Urban sites offer a distinctly different scale with streets resulting from historic patterns of development.



Fig 10: Towards the waterfront, the scale and expanse of the Humber affords for buildings that respond to the natural scale of site.

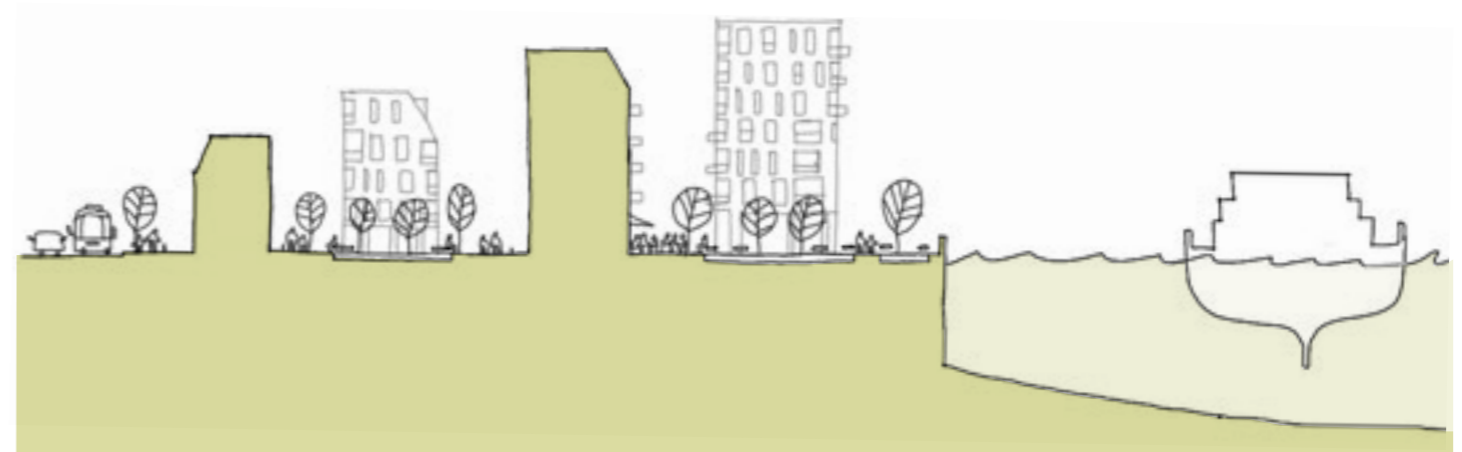



Above left: original Garden Village housing typology.



Above right: modern interpretation of a garden village house type reflecting the steep roof pitch, materials, dormer window and landscape



Above left: Typical Victorian terrace.



Above right: Modern interpretation of Victorian terrace reflecting the street rhythm, scale and proportion, bay windows, prominent entrance doors and landscape

Fig 11: Observe, absorb, and reinterpret. Context and character can be derived from analysing the local vernacular of a site. What are the local characteristic features; proportions, street rhythm, materials, bay windows, ornate entrances, gardens or chimneys?

## Context and character

Hull is a distinctive city shaped by a history of trading links with Europe, periods of prosperity and philanthropy, post-war reconstruction, and shifting economic fortunes. This can be seen in its architectural heritage. Over time a combination of urban renewal and shifting housing needs and requirements has brought new housing typologies. Some remain sought-after, while others are now unwanted and being replaced.

Responding successfully to local character, and in particular heritage assets, is an important challenge for new residential development. There is no one right way of achieving this and overly prescriptive guidance here would be counterproductive. This SPD does however prescribe to the view that good design is based on an understanding of the characteristics of places, and what makes them successful and attractive, or otherwise.

Proposals for new residential developments are expected to demonstrate what characteristics of the local context and character have been observed, absorbed and reinterpreted in their designs to positively relate new with old.

There are different ways of achieving this and it is for design teams to decide on the best response to local context and justify their design approach.

An infill, or small development, need not copy the buildings around them but must respect context. This could mean contemporary architecture and materials used in buildings that respect context through elements such as plot width, proportions, rhythms, roof line, and building line. Whereas in certain cases adopting a more faithful reinterpretation of an existing building design may be more appropriate.

## Views and landmarks

People identify better with places when features they recognise help them to orientate themselves and find their way around. Highways-dominated layouts and homogenous architecture has made some modern housing schemes in the city difficult to orientate. Future residential developments can avoid this by safeguarding important views between places or creating new ones, whilst respecting or adding new local landmarks.

Distinctive buildings help to provide reference points within the townscape but the idea loses its effectiveness if the same distinctive building is repeated several times within a scheme.

Taller or distinctive buildings should be unique and used to emphasise key locations within a neighbourhood. Their location is as important as the building itself, and should be chosen to make new developments more legible and distinctive.

Making the most of views within a layout does not have to mean maximising the visibility of a

certain feature. For instance, a long straight road leading to a distinctive building no doubt has impact, but its impact is soon digested and becomes monotonous. In most new residential development greater impact is likely to be achieved through what is known as serial vision (see Cullen 1961). The premise of this is that the scenery of townscape reveals itself in a series of staggered jerks and revelations.

A strong part of the character of Hull is its relative flatness meaning the existing topography rarely results in views and vantage points. This means designers of residential layouts have to take the initiative and design-in serial vision by siting landmark buildings, occasionally offsetting the angle of streets, tightening corners, and utilising the element of surprise in designs. This is more readily achieved when designing from the perspective of a pedestrian rather than a car driver.

Fig 12: Distinctive buildings can act as wayfinders and local landmarks within new developments to orientate people, or provide a focal point. These buildings may find their distinction in a variety of ways from their scale, architecture, roofscape or materials.





Enclosure of streets and spaces is defined by their width relative to the height of buildings at their edges. Enclosure is important in residential developments as it affects how pleasant and welcoming they feel, and how easy they are to move around.

Using layouts based on perimeter blocks will create clear and continuous building lines which front onto the street while containing private space to the rear. This allows for feature buildings on corners and at the end of vistas which create distinctiveness and help people to orientate themselves.

Design teams are expected to create strong relationships between buildings and the spaces they enclose. This will aid the creation of a positive sense of place. As a guide this means development proposals with buildings which face onto the street to create activity and surveillance; buildings which form a strong continuous building line; minimising setbacks (unless front amenity space is important to character); and occasionally offsetting junctions to frame and enclose spaces at intersections.

Experience tells us that for typical residential streets a well-

proportioned height to width ratio is no greater than 1:3 but different ratios will be appropriate in different character areas and street types. BfL12 provides further guidance on this. A 1:3 ratio will not magically result in a comfortable sense of enclosure but can be positively reinforced through a variety of ways such as: front facing gables and steeply pitched roofs; bay and oriel windows; jettisoned floors or roofs; dormers and chimneys; and structural planting such as large trees and hedgerows.

Local context and character will provide design cues in relation to what may be the optimum enclosure ratio. For example, residential development at Blanket Row in Hull's Fruit Market neighbourhood takes its cue from the historic street patterns of the Hull Old Town and has been designed with relatively narrow streets and strong sense of enclosure to respect its local context.

New residential developments leading to the creation of streets and other public spaces are expected to describe and provide drawings showing enclosure ratios (or street sections) see section 3.8 'street geometry'.

Fig 13: Enclosure can be formed from uniform perimeter blocks. Enclosure can provide a civic purpose to streets and squares, but also a domestic, small scale sense of enclosure to form courtyards and shared gardens.

#### Civic enclosure

Clearly defined street frontages and blocks form an enclosure between other clearly defined blocks. Wider distances form public squares and narrow distances form streets. Large breaks, step backs or loosely defined edges will diminish this sense of enclosure.

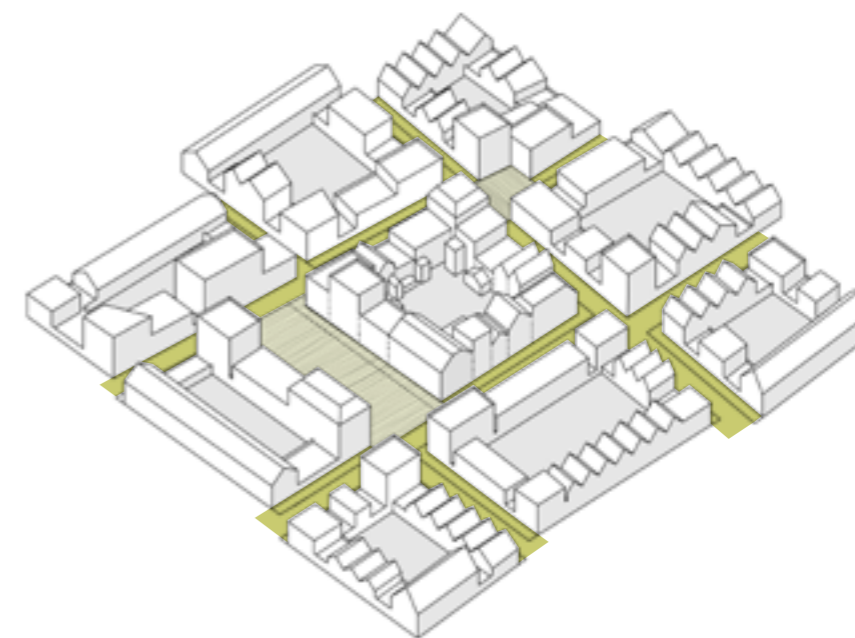

#### Domestic enclosure

Perimeter blocks in urban areas can form a network of communal courtyards, garden and play areas to reinforce a sense of community. Enclosure that results in back-to-back gardens with tall fencing does not contribute to this sense of enclosure and community but may be favoured in more suburban developments.

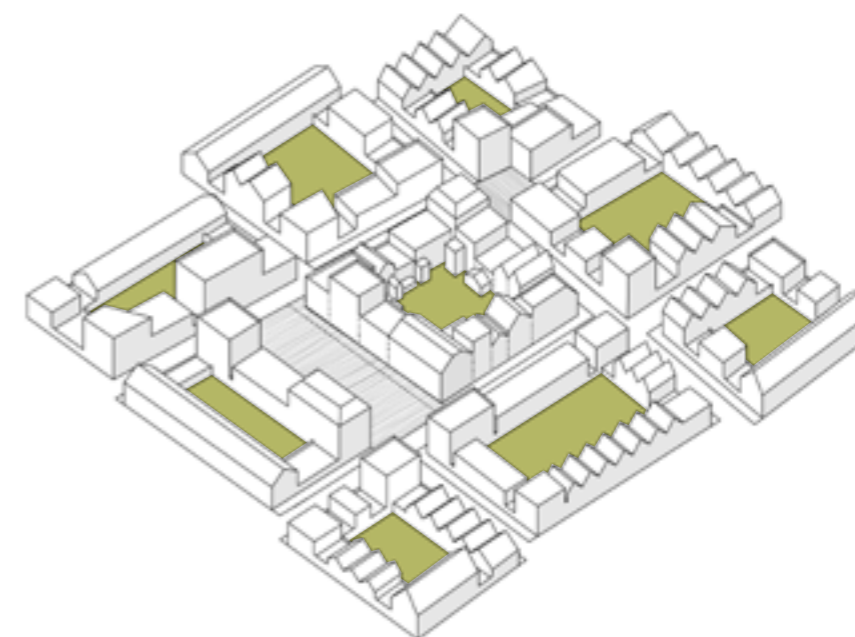





Fig 14: Amy Johnson Square, Hull - houses and apartments feature large windows overlooking the corner and public square.



Fig 15: Derwenthorpe, York - bespoke corner turning house designs provide surveillance of the public realm and make a feature of the corner plot houses

## Corners

When standard house types are proposed for corner plots this often causes unacceptable blank inactive frontages at the entrance to streets. A tailored design must be applied to corner houses which may be angled to face into the corner, or designed to face two-ways presenting animated fronts (windows and doors) on two adjacent sides.

In a majority of cases corner buildings should be designed specifically taking account of the need for good quality amenity space and daylight on the private side of the building.

In proposals with a mix of flats and houses, flats with communal rear gardens are generally better on corners plots.

Fig 16: Site corners should always be given special consideration. Buildings should respond to their double frontage with windows, entrances and openings onto both street elevations.



Materials have a major impact on the character and appearance of residential neighbourhoods. Whether new developments follow material cues from surrounding contexts, or introduce different materials to create a deliberate contrast, they should be high quality, robust, and require limited maintenance over the intended lifespan of the building.

Scale is also important when choosing materials. In individual buildings materials must work together, but should also fit within the context of the wider street, block and neighbourhood.

Too many changes in materials should be avoided. Instead material changes should have a clear rationale and be introduced to make places recognisable.

Avoid repeating the same material changes over-and-over again street-by-street. Doing this will not result in distinctive places, but rather reinforce regularity. Use material variations wisely and sparingly to detail a place and increase its legibility, rather than its sameness.

Developing a materials strategy that responds to the locality is a good place to start. In Hull the predominant building materials are brick, stone, glass, wood, slate and clay. This does not preclude the use of other materials but deviating from this will require justification, especially in areas where respecting context and townscape character is a priority.

Fig 17: The Malings, Newcastle Upon Tyne - by Ask Sakula Architects and developed by Igloo. Townscape is created through a continuity of materials that reflects the local industrial context without slavishly imitating the form or scale.







Fig 18: Byker Estate, Newcastle Upon Tyne - houses built around existing mature landscape. Pedestrian streets are prioritised through controlled parking arrangements.

## Landscape

### Working with the landscape

2.12

Visit any well-established, desirable residential neighbourhood and in most cases natural features such as street trees, grassed verges and gardens will be an important part of the character of the area. Natural landscaping needs to be an integral part of future townscapes. Where sites contain existing natural features these should be used to a scheme's advantage rather than being seen as a constraint.

Hedge rows, trees and grasses shelter most of the wildlife in urban areas and losing this is damaging in terms of ecology, and urban character. Design teams should be flexible enough to respond positively to existing landscaping and design layouts to incorporate existing natural features and seek to achieve a net gain in biodiversity as per Local Plan Policy 44.

Landscaped open space within residential layouts should be rationalised and have a clear purpose and function benefiting

future residents. Relying on the cumulative impact of small strips of landscaping and verges fragmented across a scheme is not an acceptable provision of required on-site open space.

Landscape proposals should be informed by site soil conditions, drainage and groundwater, and underground constraints such as utilities, power cables etc. See further guidance on trees and street trees.

Planning applications should make clear who will be responsible for maintaining public and private spaces whether this may be future residents, a management company, or there is an agreement with the Council, or other organisation, to adopt and manage the space. In the case of the latter the developer may be required to provide a commuted sum to cover future maintenance costs. Developers should refer to the separate SPD 11 'Protecting existing and providing new open space'.



Trees in urban areas have massive aesthetic value and make a positive contribution to the character of an area. Local Plan Policy 45 and the separate SPD 10 'Trees' seek new residential developments to incorporate tree cover by requiring three trees to every new dwelling. Over time this will have a positive impact on residential amenity, people's health and well-being, and microclimates by helping to store water during heavy rainfall, absorb pollution, help with urban cooling, and provide shade in warm weather, and shelter when it rains.

A proportion of new trees should be planted in public space as well as private gardens. Introducing street trees has knock-on effects on design as pavements and verges may need to be wider so not to impede equitable access, and planting must be coordinated with underground services. Provided there is sufficient space, trees planted in private front gardens can make a positive contribution to the street scene. However, design teams must not rely on trees in gardens alone as

some future residents will take them out.

Planting arrangements for street trees will require input from specialists on issues such as tree pit dimensions, supports for newly planted trees, species, canopies and root systems.

Research has found that twenty-five to thirty percent of new urban trees die within two years and this is often the result of decisions taken at the design stage. Design teams should take specialist advice on issues such as un-compacted soil volumes, excavations, soil recipe and soil cell systems.

The HEYwoods initiative aims to increase woodland cover and to improve the management of existing trees, woods and associated habitats in the City of Hull and the East Riding of Yorkshire and may provide specialist advice.

Fig 19: Trees existing and proposed provide multiple benefits from environmental, to ecological, to quality of life.



Tree pits provide on-site attenuation of run off water

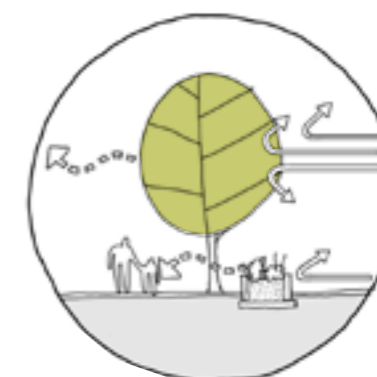

Trees can provide natural breaks in wind speeds



Integrated trees and landscape can provide green corridors to support habitats

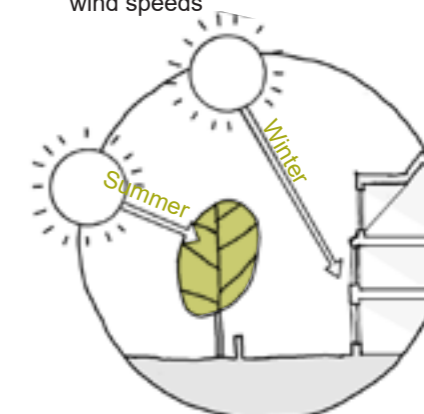

Well positioned deciduous trees can provide solar shading in the summer and allow sunlight through in the winter



Trees can contribute towards reducing local traffic noise

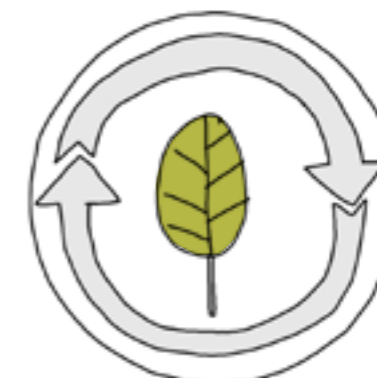

Trees provide a natural form of carbon sequestration



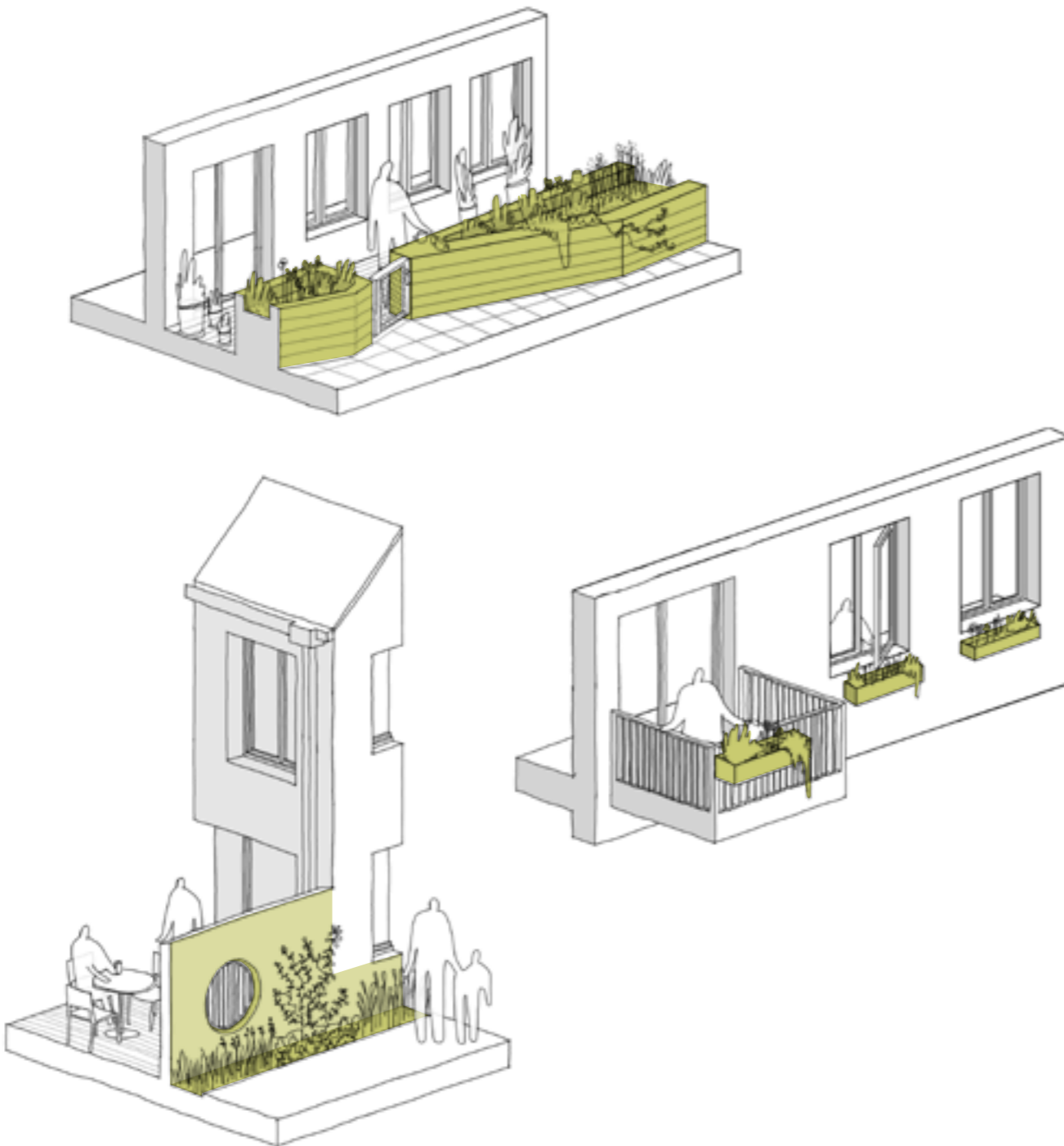

Fig 20: Every opportunity should be taken to create spaces small and large for planting and growing. This could be on an individual basis or collective shared arrangement such a micro-allotments in a residential context.

## Making space for planting

Micro-scale green spaces, as well as vertical surfaces, and roofs should be considered as potential landscaping opportunities, especially where space is limited. In all residential developments, but especially when space is tight, designs should encourage residents to supplement landscaping with features such as window boxes, terraces and balconies making the most of south facing aspects.

Outdoor spaces around residential buildings need not be the exclusive domain of one use or another. Well-designed developments will combine car parking, cycle storage, and bin storage with deep planters, planted edges, trees and areas for residents to sit, play, dry washing and enjoy the outside of their homes as they choose.

Where a design team claim 'there isn't enough space for landscaping' then the likelihood is that their proposal is over-developed.

A common design issue in residential proposals is the tension between space for car parking and on-site amenity space. Designs will be assessed on their ability to promote a balanced approach which recognises the importance of residential amenity and ecological considerations, alongside car parking provision.

Designing the two together will help achieve this balance i.e. landscaping edges to parking areas, and incorporating space for planting after every fourth parking bay. If space is tight a parked car only needs two parallel strips of permeable hard landscaping, between and either side of which can be soft landscaping.

Where parking is to the front of properties it is recommended this is integrated with an element of landscaped front garden with the soft landscaping arranged in such a way that it is not easily converted into another parking space. This will impact on the design of terraced housing in particular.

## Sustainable drainage

Homes in Hull are at risk of flooding from all sources: river, tidal, rainfall, surface water, groundwater, and sewer.

Hull is pioneering new innovative approaches to water management based on the principle of **Living With Water**. The design and layout of residential developments should embrace this approach and this means integrating sustainable rainwater management as positive, above ground, visible features within the townscape.

The SPD 'Living with Water – Approach to Surface Water Drainage' includes core design principles and is essential guidance for designers and developers.

New residential developments should include above ground features capable of managing drainage in and around properties by slowing and holding back rainfall.

Sustainable drainage must be integrated within site layouts, street design and gardens. A preferred approach is for all volume to be captured and intercepted within above ground sustainable drainage. However, this can take up a lot of available space so in many cases a combination of above ground sustainable rainwater

management and below ground storage tanks and oversized pipes will offer an appropriate solution.

Design teams should consider keeping road surfaces low relative to verges, footpaths, and built frontages and using gentle gradients to direct flows away from homes and existing development.

It is essential for developers to agree with the Council and Yorkshire Water the type and extent of sustainable drainage proposals at an early stage in the design process and establish who will adopt and maintain the scheme and what level of committed sum is likely to be required for this.

1. Rainwater butts and greywater recycling
2. Existing natural watercourse
3. Wetland areas
4. Large swale
5. Street tree pits
6. Permeable paving in streets
7. Filter strips and retention pond in residential squares
8. Micro-wetland within courtyards
9. Sunken squares with retention
10. Green roofs
11. Infiltration trench
12. Bio-retention
13. Brown roofs
14. Bio-retention in commercial area
15. Aqua green
16. Permeable paving
17. Rain gardens

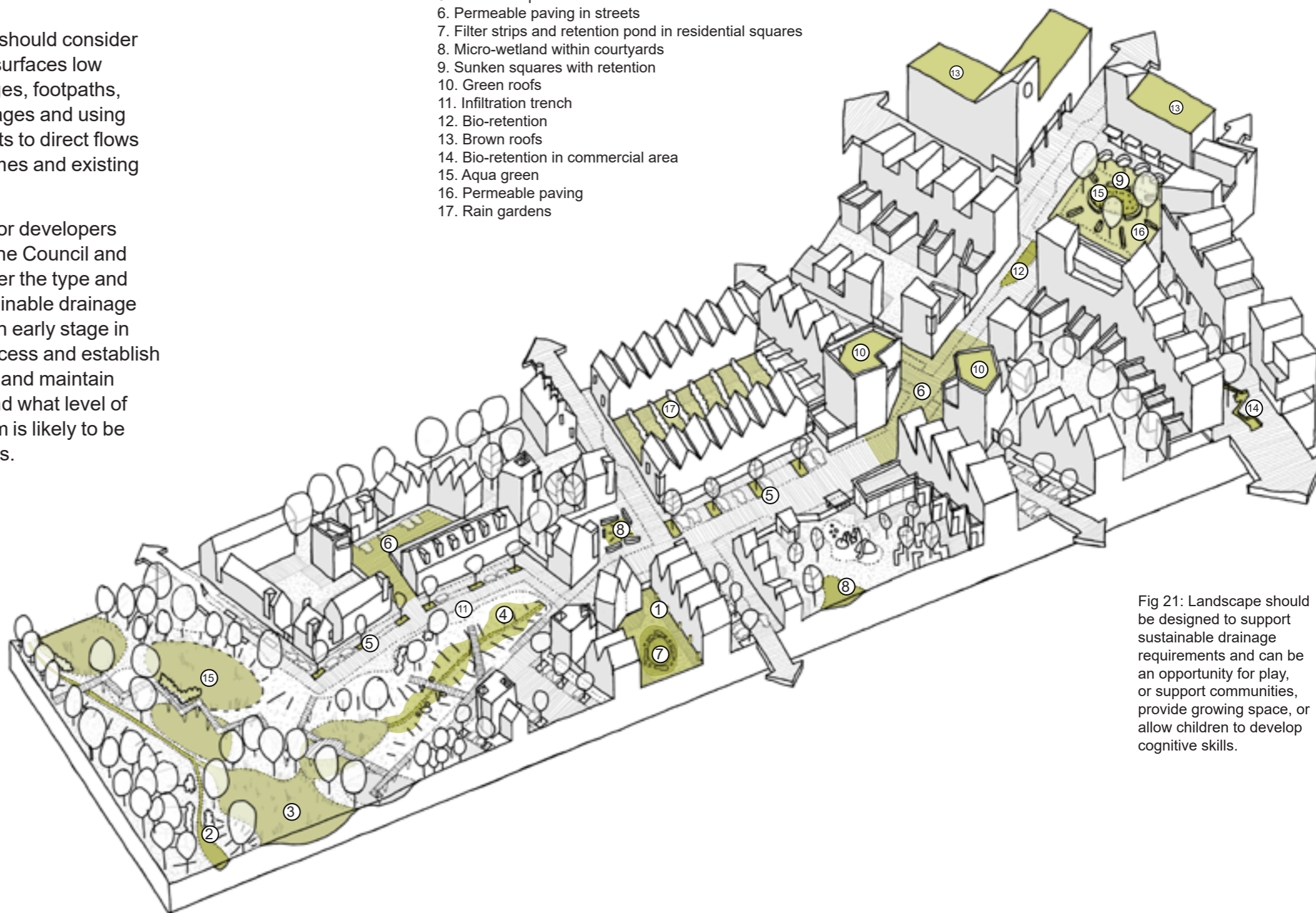
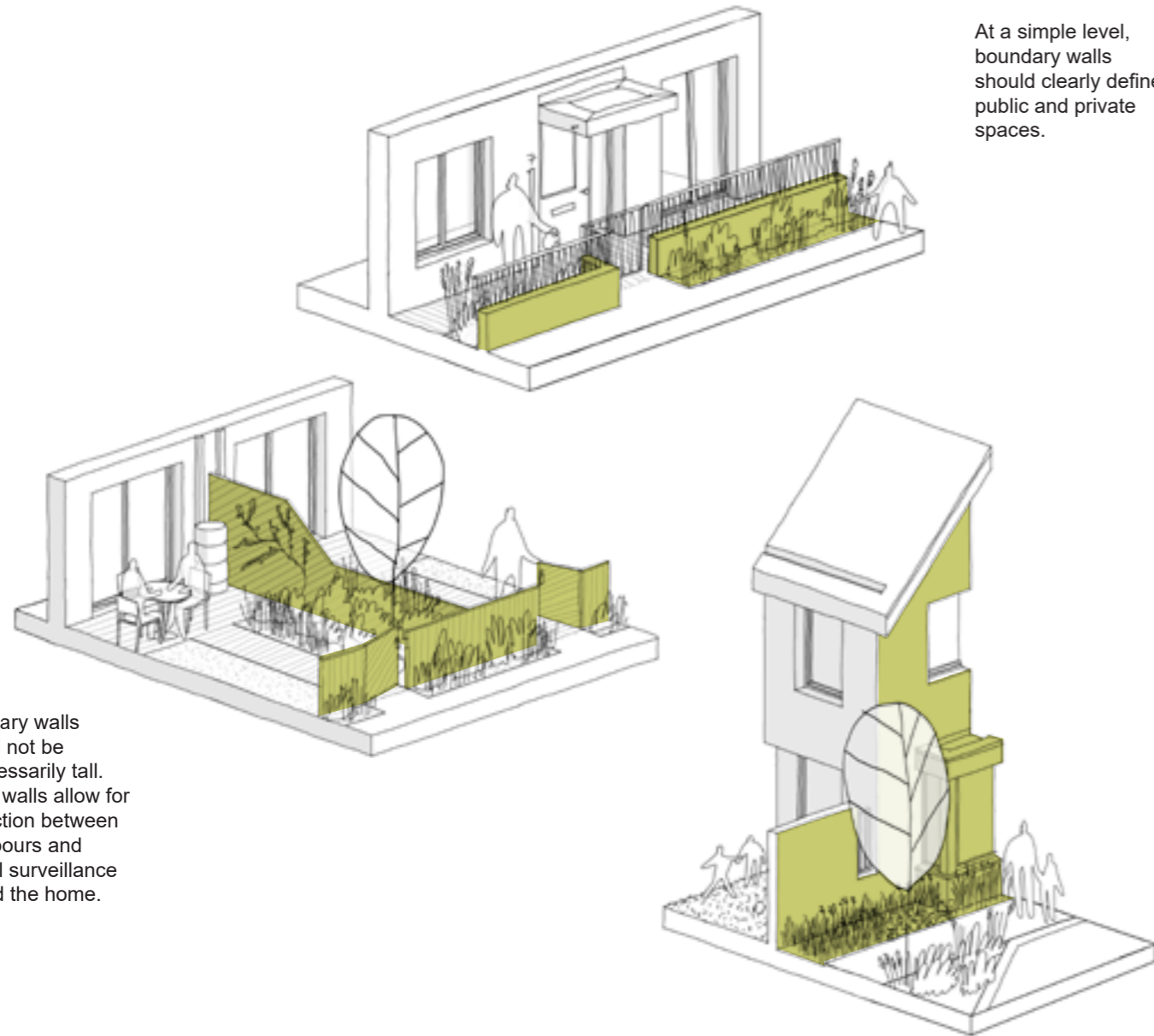

Fig 21: Landscape should be designed to support sustainable drainage requirements and can be an opportunity for play, or support communities, provide growing space, or allow children to develop cognitive skills.



## Boundary treatments



At a simple level, boundary walls should clearly define public and private spaces.

Fig 22: Boundary designs are essential to creating clear definition between public and private realms. They also provide the opportunities for casual surveillance of the street, places for enhanced planting, architectural details. Continuity of materials is important to provide a legible architecture.

Boundary walls should not be unnecessarily tall. Lower walls allow for interaction between neighbours and natural surveillance around the home.

Side boundary walls offer the opportunity to provide continuity as well as space for breaks between houses, planting and side windows for overlooking.

Boundary treatments should reflect both immediate context and local character. For some developments context may determine that boundary treatment must function as a security feature, in which case it is likely to be robust and designed in such a way to withstand attempts to get through and over it, but without creating a 'fortress' feel. Whereas in other contexts boundary treatments will simply frame a garden, or mark the divide between public and private realms. In these developments a more welcoming and permeable design is more appropriate.

Design teams are strongly recommended to take into account Secured by Design principles. These now form part of Building Regulations Part Q.

Providing high quality, robust and long lasting boundary treatments from the outset will deter future residents from erecting their own fencing and walls which may not respect local character, and result in a hotchpotch of treatments along the street.

Boundary materials should be designed to allow for surveillance of the street and should not

obscure daylight into homes. Where solid boundaries are proposed for frontages, such as walls and fences, these are better when low level (below 1 metre) to maintain good levels of surveillance and light.

Side boundaries can be problematic where they are exposed to the street, for example on corner plots. Corner plots should be designed as having two frontages and boundary treatments should reflect this in their design. In some cases high solid boundaries, such as walls and fences, can be made more acceptable by puncturing them with openings, cutaways or trellising to allow daylight to penetrate and climbing plants from the garden side to grow through.

Continuity of materials used for demarcating boundaries and paths around a development will be important in aiding legibility. In the majority of cases acceptable boundary treatment materials will be hedging; wooden fencing; metal railings; and brick or stone walls. A combination of materials can work well and look good.



## Designing Streets and Public Space

Fig 23: The Avenues, Hull. Positive street frontages are achieved through large bay windows, set back and articulated front doors, front gardens, generous soft landscape, wide pavements and mature trees.



## Residential Streets for All

### 3.1 Streets not roads

Streets are our most common and arguably most important public spaces. They serve many different roles: as the setting for our homes, places to meet neighbours, playing-out, jogging, walking, cycling, parking and the circulation of traffic.

Interaction between users is inevitable and rather than attempting to separate users it is better to design streets to encourage their responsible use by all.

### 3.2 Animated street fronts

Frontages on residential streets are likely to be less varied than their High Street counterparts, and therefore less active, and quieter in character. This does not excuse dull, blank façades and buildings lacking interest.

As a rule of thumb, design teams should stick to the mantra 'public fronts and private backs'. Doing so will mean buildings face the street with frequent doors and windows overlooking the street, whilst respecting people's need for privacy at the back of their home.

Residential developments often struggle to achieve active fronts

because certain uses, such as shops and cafés and the activity they generate are either infrequent or absent. Hence the requirement for animated, as opposed to active, frontages.

Design teams can create animated street fronts through a variety of ways such as frequent front entrances; pairing front doors together; living spaces and windows overlooking the street; incorporating planting and street trees; and architectural detailing such as bay windows, balconies, porches and other such features which animate frontages (see figure 23 and 24).

Fig 24: Staithe housing, Gateshead. Front gardens with low fences and varied planting creates a buffer between houses and street, whilst clear visibility of entrances and front windows help animate the street.





## Equitable places

Residential developments should recognise that people's needs are not all the same. Current and future residents will include people with pushchairs, toddlers, older residents and residents with cognitive impairments, physical disabilities and mobility issues. Taking into account the full range of users is to take an inclusive approach to design.

At the scale of the neighbourhood, street or block new developments should be designed to enable continuous, safe, visible and convenient pedestrian movements. It is important to get the details right and the easiest way to achieve this is to design from the

perspective of the pedestrian with limited mobility, in particular wheelchair users. This way the design should ensure enough safe inclusive crossing points on desire lines; appropriate footpath widths; routes clear of obstacles; measures to prevent cars from parking on pedestrian surfaces; the provision of resting places compatible with wheelchairs and scooters; and entrances to buildings which are easily distinguishable.

Fig 25: Marmalade Lane, Cambridge by Mole Architects, developed by TOWN. Lower car parking ratios and site strategy allow family friendly streets, provide spaces to support community life and play.





## Addressing flood risk and achieving access for all

There is an ever present risk of flooding in the city and Local Plan Policy 40 sets out how flood risk is to be addressed in planning applications and the Council's Strategic Flood Risk Assessment provides the evidence for the policy approach. In a majority of cases for residential developments finished ground floor levels will have to be raised either 300mm or 600mm above average site level, or adjacent road level, whichever is higher.

At the same time Local Plan Policy 21 asks for at least a quarter of market housing, and at least half of affordable housing, to meet the requirements of Building Regulations M4(2) accessible and adaptable dwellings. To do so requires step-free access.

These two requirements are equally important but achieving both together can be challenging. For instance, to provide ramped access to a property with a flood risk of 600mm can require long ramps. In some existing housing areas, and in certain house types this is very difficult to achieve. Raising site levels generally can cause problems for surrounding housing in terms of their relative height, overlooking and surface water run-off causing more flood risk to neighbouring houses.

It is strongly recommended that ground floor levels and access arrangements form part of the earliest site layout and design considerations. Leaving access requirements until the end of the process and retrofitting ramps is unlikely to result in acceptable solutions and the results can appear awkward and ill-fitted.

There is no standard design and appropriate solutions require different approaches for different house types and accessibility categories. The drawings that accompany this guidance text explore this issue for a range of building types and densities and offer some suggested solutions.

Thinking of how parking is integrated and using this space to achieve gradients can be one solution, as could indented entrance thresholds with living spaces projected forward.

In most cases keeping road surfaces low relative to everything else is a good start and gradually building up ground levels towards building entrances.

Fig 26: The relationship between car parking and housing typology will define the quality of streets in a development. The diagrams show some ways to integrate parking within the buildings, to achieve compact street widths, reduce the visual dominance of cars and achieve the raised entrances required to protect against flood risk.

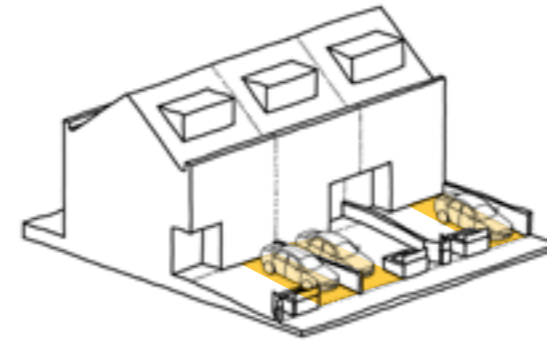

On curtilage parking in front of houses can help achieve gradients but also generates wide streets dominated by cars and hard-standing which has a negative impact.



Integrated garages reduce the visibility of cars and allow for more compact street widths. A level entrance threshold is created inside the garage, paired with a stepped entrance from street level.

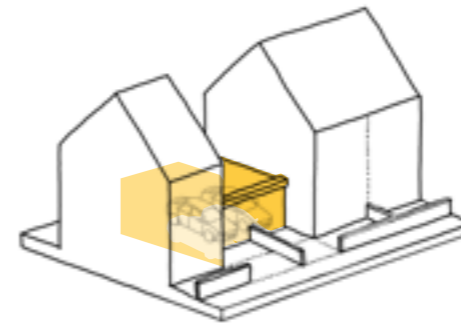

Alternatively, side garages or car-ports achieve the same effect. This approach breaks the continuity of street frontage but reduces the dominance of cars parked in frontages.

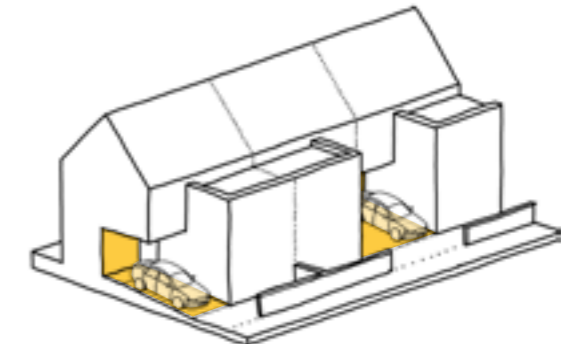

Semi-recessed parking enables living spaces to be pushed forwards to provide outlook and enclosure to the street.

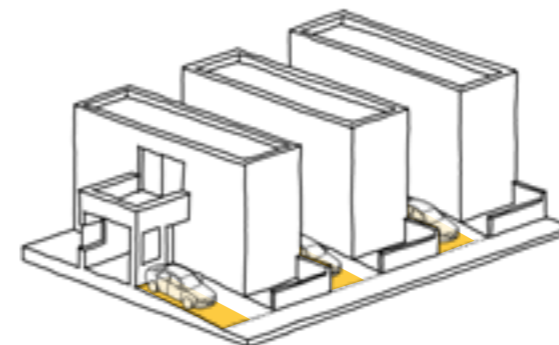

Indented layouts with pronounced entrance 'courtyards' can help to achieve a distinctive street rhythm at the same time locate parking discretely and achieve gradients.

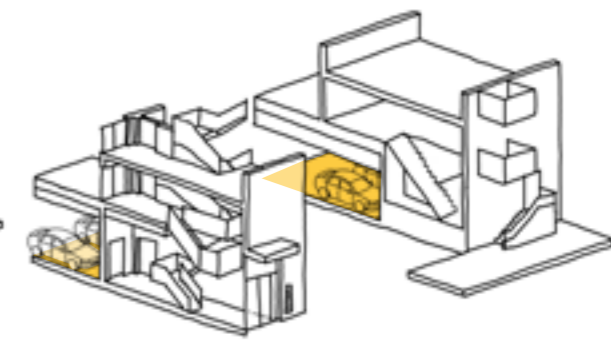

Maisonette typologies will be more appropriate for urban sites. This example shows car parking concealed underneath a rear courtyard. Active street frontages are maintained and stepped front entrances are paired with level entrance thresholds from the car park or courtyard.

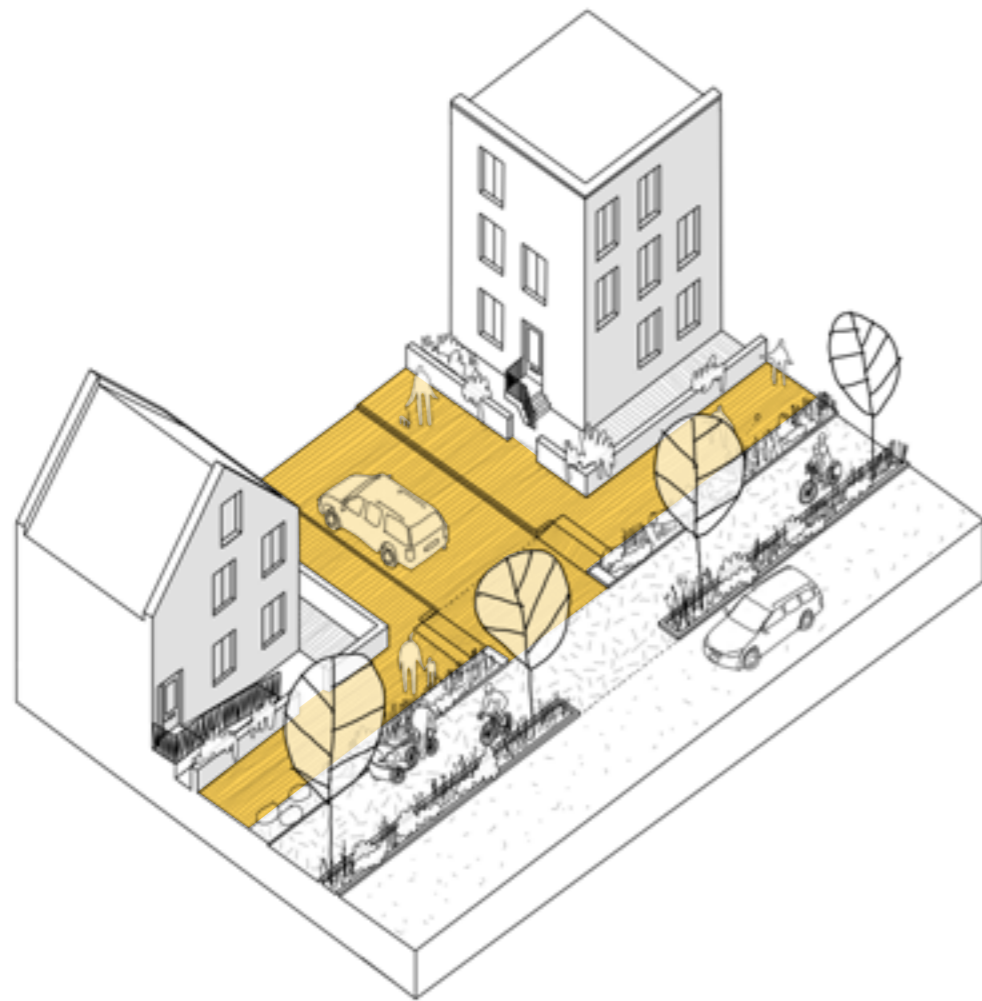

Fig 27: Pedestrians and cyclists should be given priority over vehicles when it comes to movement. Junctions should prioritise pedestrian and cycle movement and continuous or shared surfaces used in residential streets to create the sense that cars are guests in pedestrian space.

## Surface materials and crossing points

Materials used for carriageways and pavements must be appropriate to their function within the street and to the character of the area. Surface materials should be one of the key attributes that a development shares with the surrounding area in order to maintain local distinctiveness. Exceptions to this are where materials from the surrounding area are viewed by consensus as negative, or they do not meet the needs of disabled people or are otherwise unfit for purpose.

Surface materials should be suitable for use by disabled people. Design teams should avoid using patterns that may create visual confusion and potential hazards for visually impaired users. In the majority of new residential streets a conventional kerb should be

provided. This is because pavements that are level with the carriageway are not detectable by walking canes and assistance dogs and therefore difficult to negotiate for blind and partially-sighted people.

Crossing points at side-street junctions should be located near to the mouth of the junction keeping the desire line for pedestrians as straight as possible. It is not acceptable to design junctions, crossings points and/or dropped kerbs so pedestrians have to divert down a side street in search of a safe, accessible crossing point.

## Positive public places

Well-used and valued public spaces tend to be those that are well-overlooked with a strong sense of enclosure provided by surrounding buildings. Where enclosure from buildings is weak, landscaping can help improve enclosure and definition of the space.

Avoid layouts that create leftover spaces with no obvious purpose and not properly faced by buildings. Open space should have a clear purpose and function designed into the layout.

On-site play spaces are often a requirement of the planning system. To ensure they feel safe and are well used they should be overlooked by buildings and

located in busy places, ideally at the convergence of two or more pedestrian desire lines. Avoid locating play spaces in locations which conflict with the private rear amenity space of dwellings. Hull City Council encourages design teams to explore a variety of types of play spaces including proposals for natural playscapes and those designed to allow children to develop cognitive skills.

Fig 28: Open spaces which form an integral part of the site layout will be better used and more valued by residents. Open space should be designed to encourage use, for instance by directing access routes through and across it and removing barriers such as fences and gates.

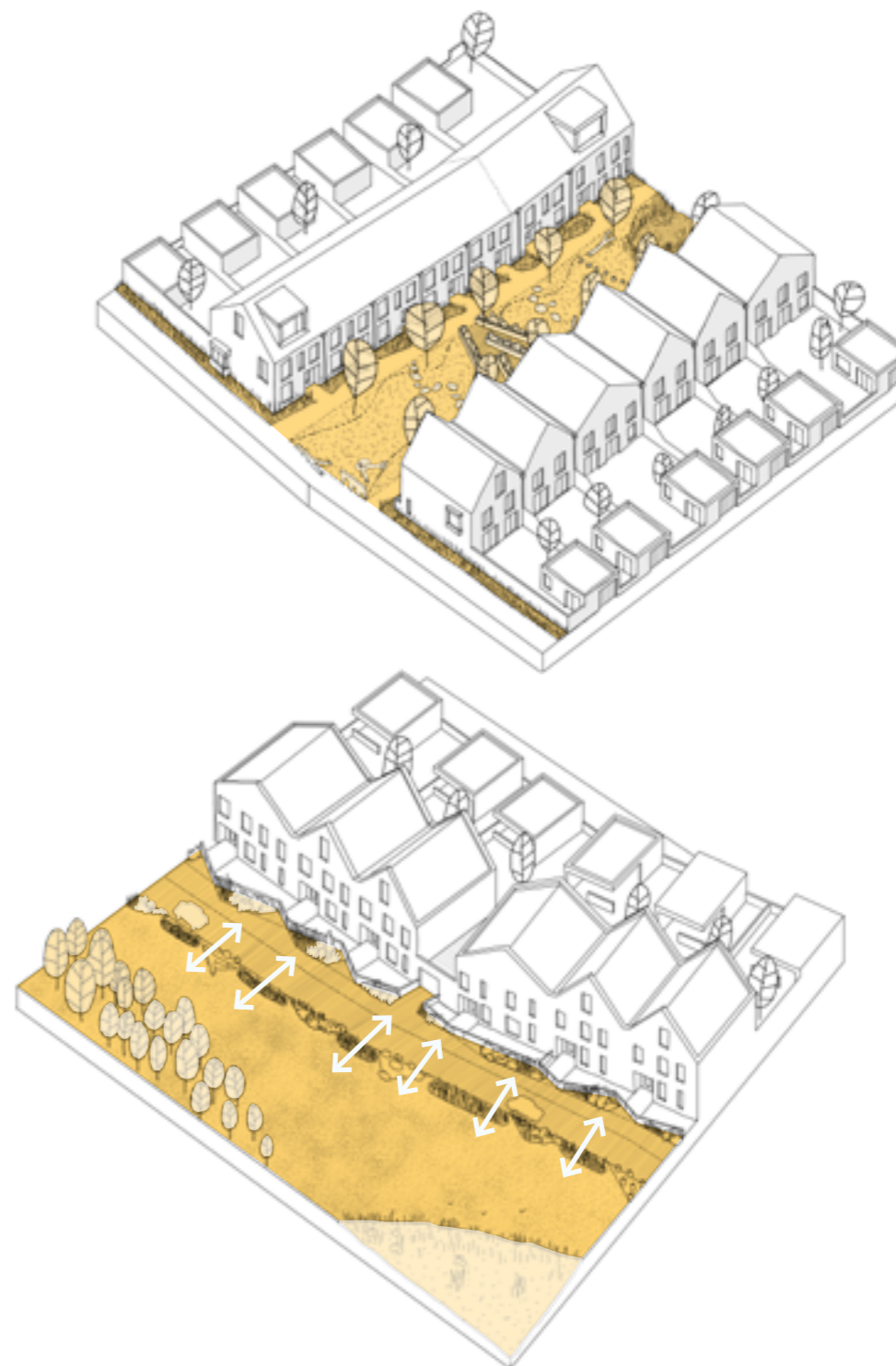





Fig 29: St. Chad's, Thurrock. Cars are excluded from the central street and the swale is made the focus for the main pedestrian route through the site.

## Residential street types and hierarchies

3.7

Large-scale residential developments are likely to be involved in the creation of a variety of residential street types. On such proposals design teams should develop a street hierarchy, with different design characteristics and enclosure ratios applied to each street type taking into account their role and function in the hierarchy.

New residential development proposals that involve the creation of new streets are expected to describe their design approach to streets as part of their application. Applications should include street section drawings to help articulate their design (also see 3.8 Street geometry).

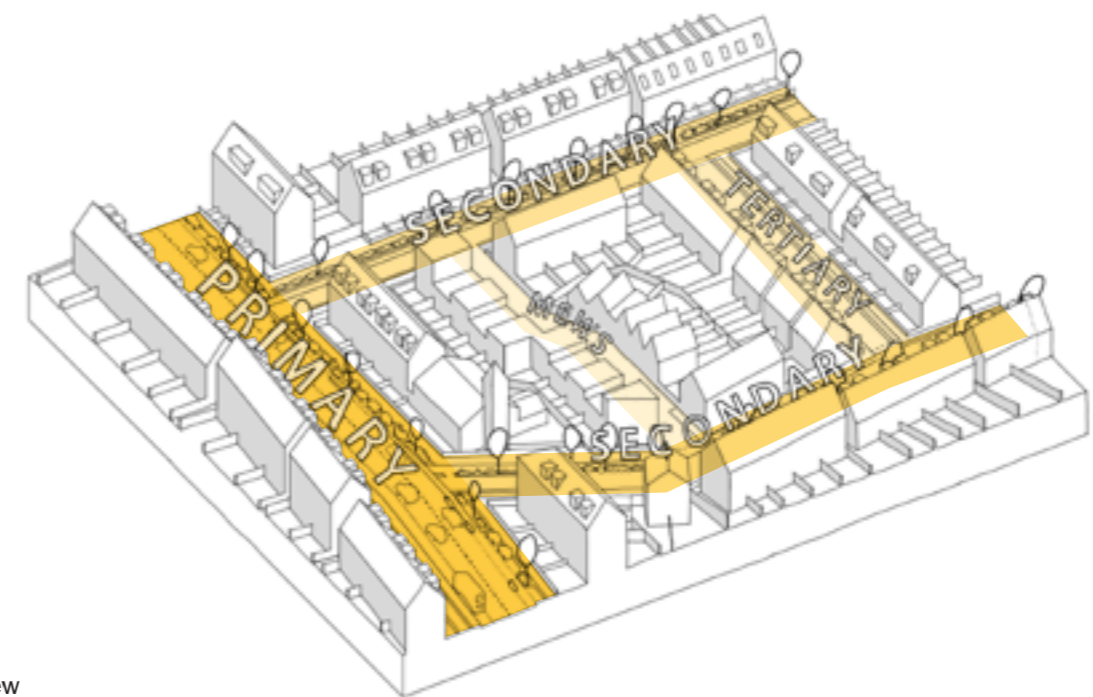

Fig 30: Street hierarchies set out details that can define the character of new neighbourhoods. Different types of streets should be clearly described in terms of their width, intended use, landscaping, parking and the type, scale and character of buildings along them.

## Street geometry

It is not the intention of this guidance to set prescriptive detail relating to street geometry, rather design teams are recommended to follow the principles and detailed guidance contained within Manual for Streets.

Street design is a critical element in the creation of an identity and sense of place. Design teams are expected to consider highway design in its townscape context. In an urban context such as Hull new residential streets should generally be designed for speeds of 20mph and less. In design terms pedestrians should be given the highest priority, and vehicles the lowest priority.

Residential schemes are sometimes proposed with overly-wide carriageways as if designed from the perspective of a refuse lorry. This is not an appropriate design approach. Highway dominated designs can destroy townscape character, and also signal to drivers that they, rather than pedestrians, have priority.

On lightly-trafficked residential schemes a more befitting design approach may be to vary carriageway widths to as narrow as 3.7m in places, and tighten corner radii so that vehicles have to slow down before turning corners.

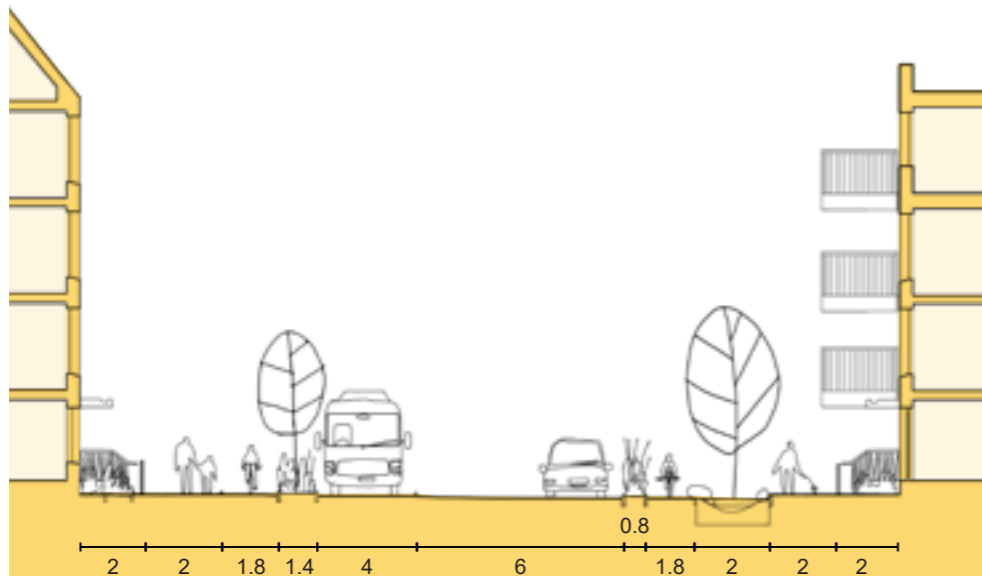

Fig 31: Primary streets are defined by wider carriageways with bus lanes and segregated cycleways. Pavements may be wider in places to accommodate thresholds to shops and cafés.

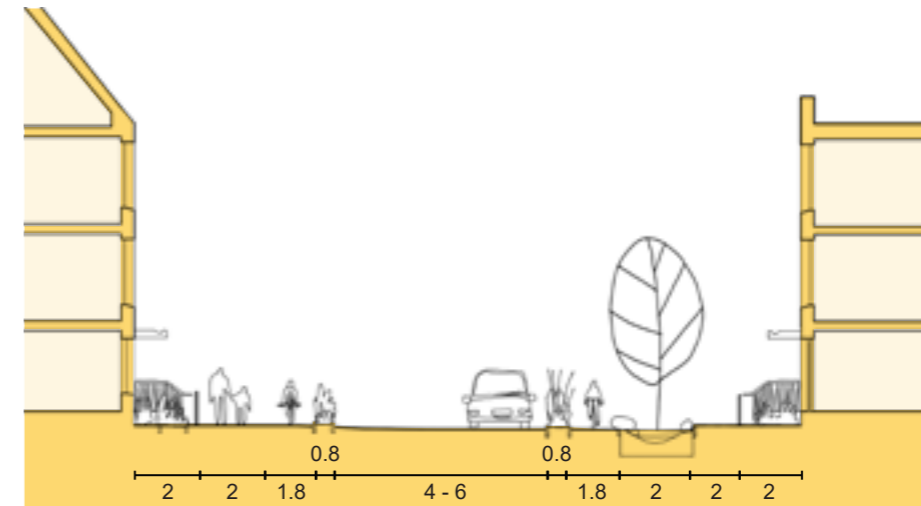

Fig 32: Secondary streets will be vehicular routes but should have clear, designated cycleways and footpaths.

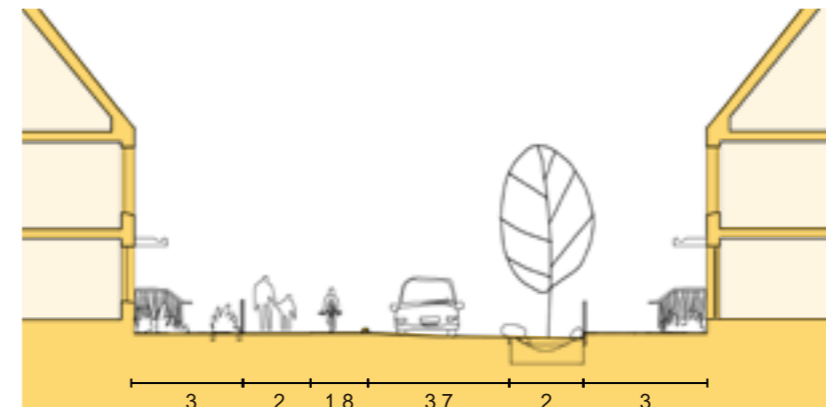

Fig 33: Tertiary streets should feel pedestrian focused with designated cycle routes and integrated landscape. The carriageway could be as narrow as 3.7m to reduce the emphasis on vehicle movement and parking. Private gardens provide privacy from the street and opportunities for soft landscape.

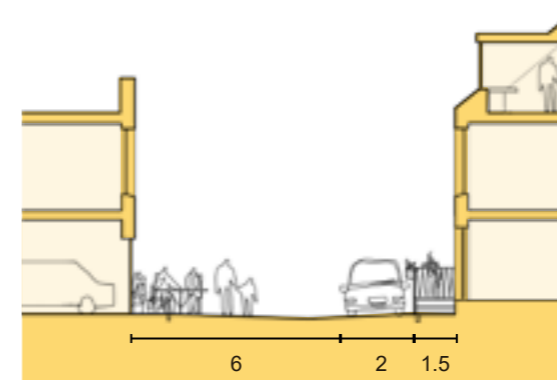

Fig 34: Mews streets are traditionally defined by their informality and lack of structure of pavements or highways giving the street a pedestrian focus with little to no visible parking.



## Parking

### 3.9

## Integrating space for parking

As car ownership continues to intensify parking is a significant issue for new residential development in Hull. It can be an emotive issue leading to disputes between neighbours, and a contentious issue leading to planning refusals. With this in mind parking has to be designed carefully, and parking capacity needs to be flexible. What works on one site, may not work on another.

Where and how vehicles are parked has a massive impact on how a place looks, feels and functions. There needs to be a balance between achieving sufficient parking without it being over-dominant and detrimental to other aspects of good design.

Experience tells us that people prefer to park their cars in front or to the side of their homes. Added to this is a need to find space for two or more parked cars for most dwellings. BfL 12 recommends using a range of parking solutions appropriate to site context and the types of housing proposed. This situation calls for flexible design approaches, and flexible decision making with regards to car parking, such as allowing properties with one allocated

on-plot space, and one space positioned within the street scene or to the rear.

Attempting to accommodate all parking on-plot is inflexible and incompatible with certain forms of development, such as rows of narrow terraces.

Garages in the ground floor of apartment buildings should be designed to avoid dull, inactive frontages. In more urban areas it may be appropriate to insert smaller units on the perimeter facing the street i.e. small retail units, cafes or kiosks. This approach will not always be viable, in which case design teams should consider how ground floor frontages can contribute to the animation of streets and spaces through materials and lighting etc.

Design teams are expected to declare a parking strategy and how it contributes to the site layout at pre-planning stages. Alternative strategies should be tested to demonstrate suitability.

New residential development within the city centre is only expected to meet 20% of the standard provision set out in the Local Plan.

Fig 35: Two car parking spaces per dwelling leaves little space for anything other than parking. A poor parking strategy results in poor spaces in-between buildings.

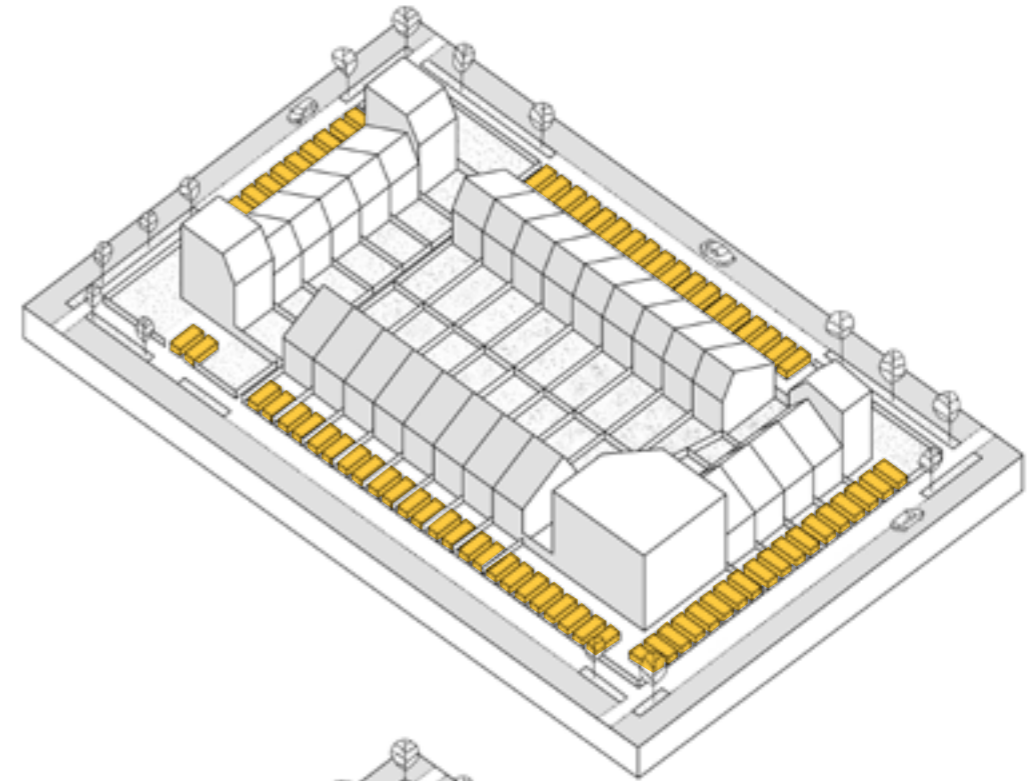
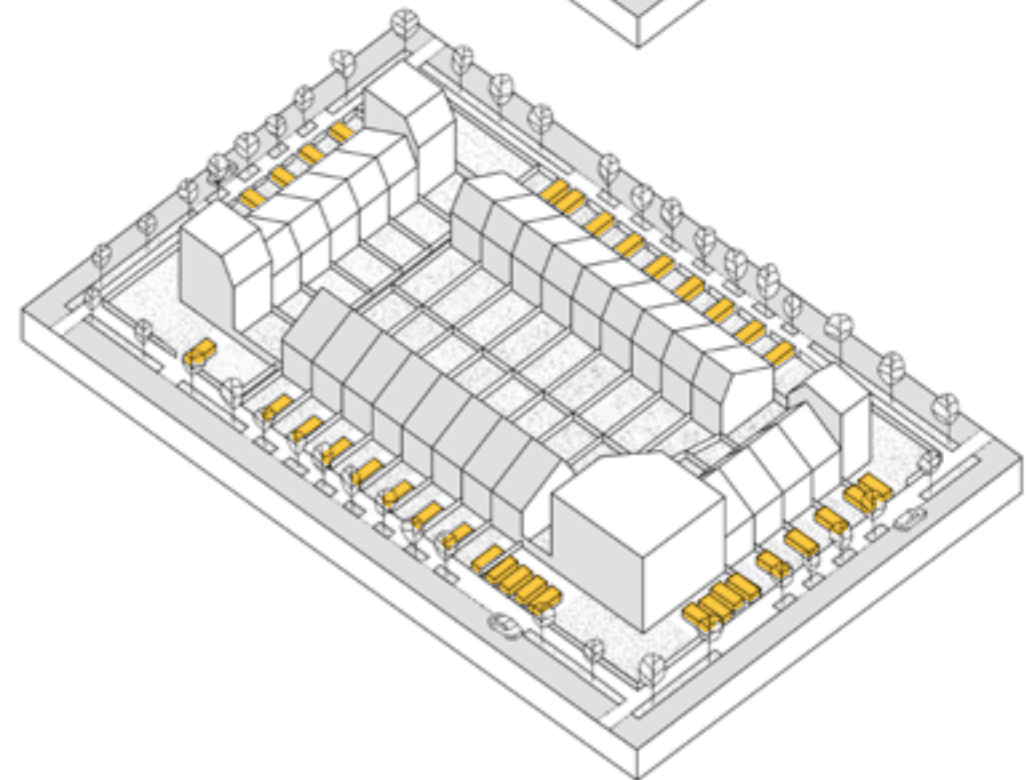

Fig 36: A one car parking space per dwelling reduces the pressure on front gardens and streets allowing more space for planting and soft absorbent landscape to improve amenity and mitigate against flooding.





## Parking design principles

To be acceptable, parking on new residential developments will need to respect the following design principles:

- parking dominated schemes are not appropriate;
- parking to be provided in a variety of ways including where appropriate some on-street bays;
- ‘fly-parking’ derived from wiggly street design should be avoided;
- pedestrians have priority over parking and moving vehicles;
- on-plot parking is generally better at the side of the house rather than the front;
- on-plot parking is better bumper-to-bumper with the first space behind the building line, as opposed to side-by-side in front of the building line;
- where parking is to the front of properties it is recommended this is integrated with an element of landscaped front garden with the soft landscaping arranged in such a way that it is not easily converted into another parking space.
- where rows of narrow terraces are proposed consider positioning parking within the street scene to reduce vehicle domination;
- garages must be of sufficient dimensions to allow for the primary purpose of parking a vehicle;
- accessible parking bays for M4/1) and M4/2) houses should be +900mm and +1200mm respectively;
- parallel parking, as opposed to perpendicular, works better in terms of overall street design; a mix of parallel and perpendicular can work, but perpendicular on both sides of the street does not (streets become too wide and enclosure too weak); and
- parking spaces should be integrated with generous planting to balance the visual impact of parked cars. Incorporate a tree, or other SUDS feature, for every three bays.

Fig 37: Containing parking to the rear of housing allows pedestrianised streets and frontages onto green space.

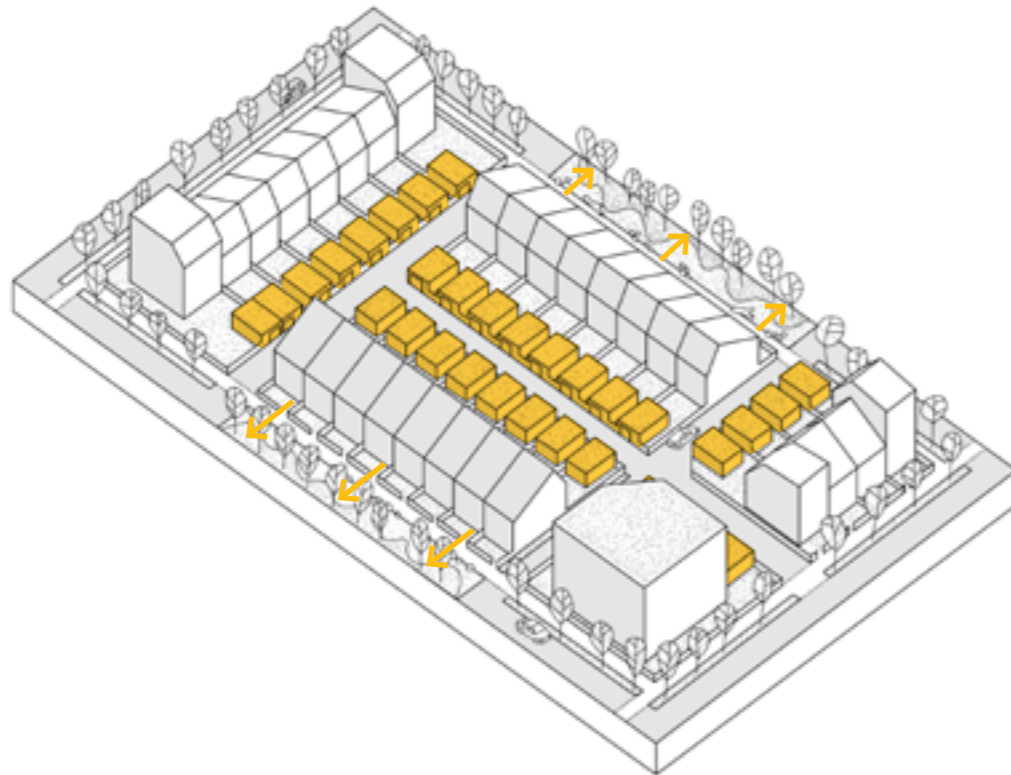
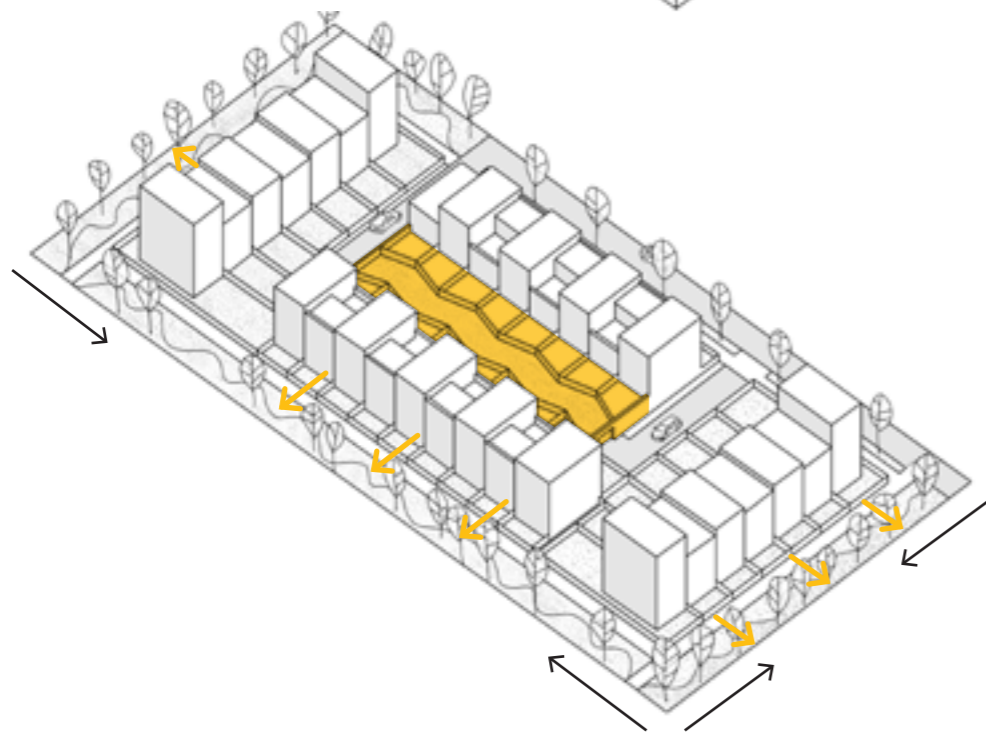

Fig 38: Alternative parking models should be considered. A podium (as illustrated) over a semi or submerged basement allows car-free streets and maximum soft landscaping which brings social and environmental benefits. This may also allow for higher density housing and more efficient land uses.



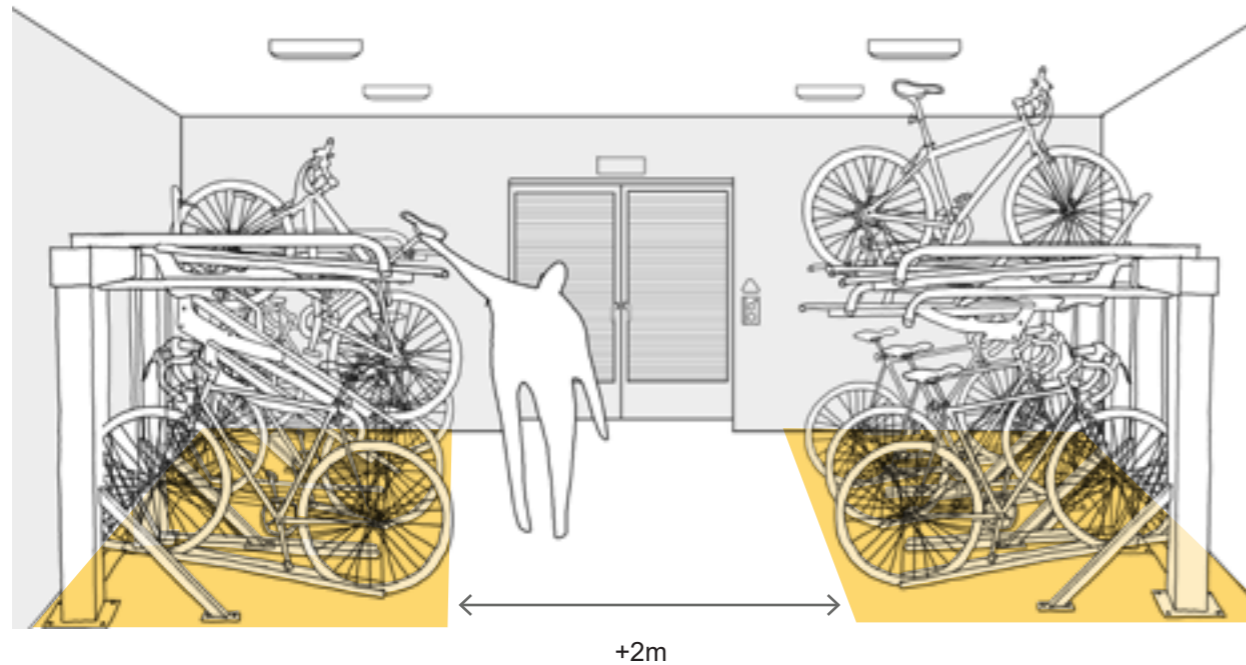

Fig 39: Double stacked bike parking systems are the most space efficient means to internally store residents bikes. Typically 2m circulation space is required to carefully access these systems.

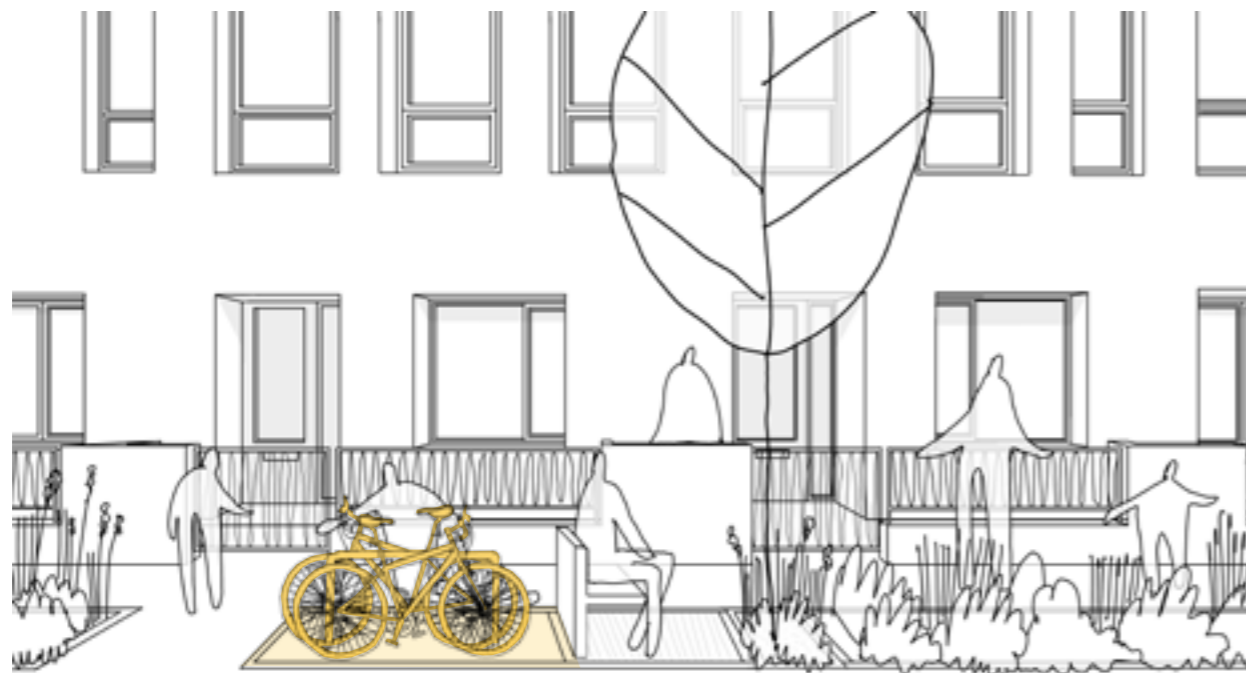

Fig 40: Visitor cycle parking should be considered an essential part of the street furniture along with bins and street lights. Cycle stands can be integrated thoughtfully as part of the site landscape strategy.

## Cycle parking

Cycles are not suited to long-term outdoor storage as they are vulnerable to theft and adverse weather. In the majority of larger homes (4 bedrooms and over) and homes with garages, space for cycle storage can be reasonably accommodated without dedicated facilities.

Cycle storage in garages must not prevent them being used for their primary purpose of parking a motor vehicle. Any property with a decent sized rear garden (that is a garden at least equal to the ground floor footprint of the dwelling) should be capable of accommodating secure and covered cycle storage.

In smaller dwellings more bespoke solutions may be needed for internal cycle storage. Internal storage areas should be located as near as possible to a main point of access to prevent the need to bring cycles into living spaces. In homes of a more contemporary design it may be possible to accommodate secure, vertical cycle storage adjacent to front doors or as part of recessed porches.

Hallways, balconies and terraces do not make appropriate places for cycle storage.

A common solution for groups of smaller properties or apartment buildings is to provide communal cycle parking facilities (Fig. 39). These should be secure, indoor and located on the ground floor. Often cycle storage competes for limited space with parking and bin storage but designs must take account of the need for at least a 2m circulation space. Where space is tight, stacked storage solutions may provide a solution.

Outdoor cycle parks should be weather-proof and are best located in well-overlooked and well-lit locations. Depending on the amount of provision required facilities can be purpose built outbuildings within enclosed courtyards, or in several smaller facilities integrated with car parking and amenity space.

Outbuildings should relate to the architectural language of the main buildings. 'Off-the-shelf' bike parks should be avoided.



## Recycling and waste bin storage

Most properties in Hull now have three wheelie bins and in the future recycling capabilities and segregation may result in even more. Bins left out in the street are unsightly and people generally don't like bins cluttering up their private outdoor space. Where the most practical storage point is at the front of properties, or in shared courtyards, this should be integrated sensitively, be screened, enable flow of air

and must not block thresholds or entrances. There are both individual and collective design approaches which will impact user behaviour, management, maintenance and street layouts.

Design approaches should be made explicit at pre-planning stages. Sometimes a combination of different strategies may be appropriate across larger sites and different typologies and tenure groups.



Fig 41: Marmalade Lane, Cambridge. Bin stores and communal cycle stores are an integral site feature, designed to be robust and secure, whilst at the same time sharing an architectural language with the residential buildings on the site.

Fig 42: Like car parking, recycling and waste storage shapes the urbanism of new housing due to their inherent storage and access requirements.

### Individual Strategies

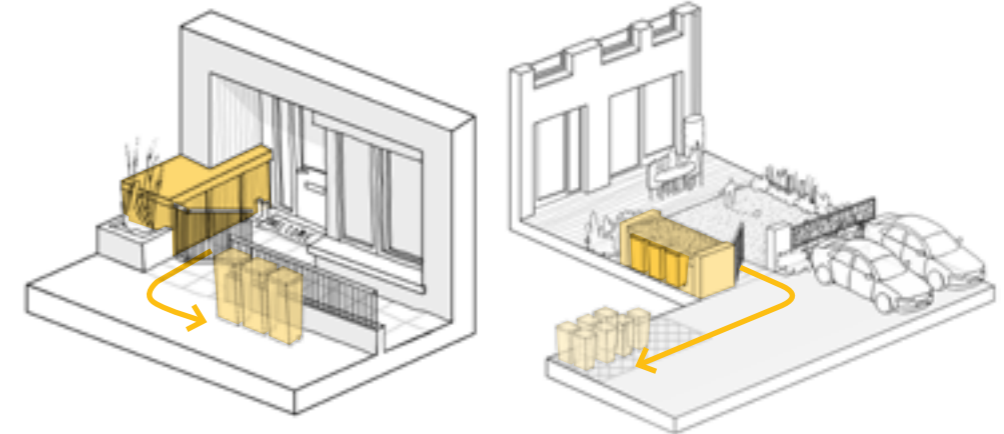

**Front storage** can provide a holding space for bins provided the design is integral with the houses and landscape. Palette of materials must relate to the housing, and materials must be ventilated, robust and able to withstand daily use.

**Rear storage** can vary in form, but should always be protected from the elements, with ease of access to rear streets, or within short moving distance to a designated and accepted holding space.

### Collective Strategies

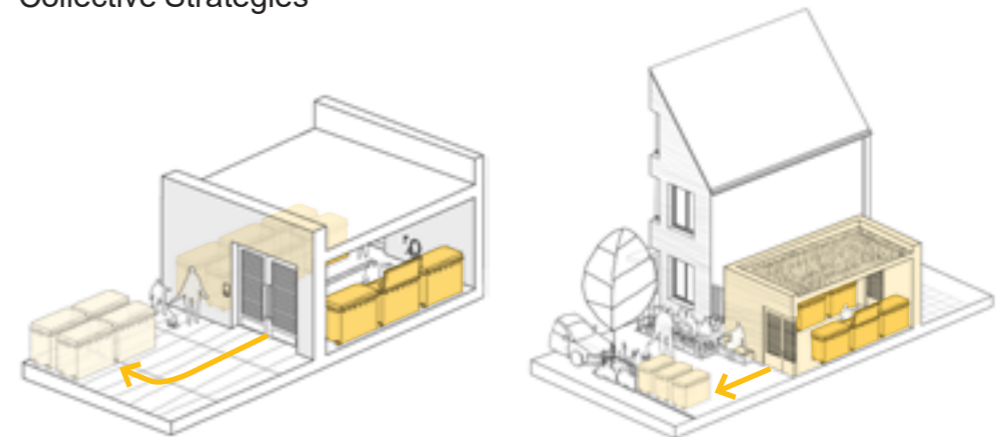

**Internal** storage provides bin free streets and gardens. Whilst typically used for apartment typologies, it could also be appropriate for low-rise housing. Designs should consider ventilation, fire compartmentalisation, robustness, cleaning/maintenance and efficiency through internal rotation of bins via a management strategy to reduce internal floor area.

**'External'** storage can be free-standing or integrated into built form and covered to provide a positive outlook for residents. A similar palette of materials to the main architecture will maintain the quality of the development, with robustness and ventilation also key requirements. Off-the-shelf solutions are generally not appropriate.





Fig 43: The Garden Village, Hull.



## Design approaches

At its best and most sophisticated new residential building design offers familiarity in terms of capturing something of the distinctiveness and best qualities of the local area, yet contains elements, perhaps materials and window styles, which reveal it to be contemporary.

Avoid poorly executed pastiche designs that neither add new qualities, nor successfully match the quality of older traditional buildings. Where design teams have decided to emulate an existing architectural style they are advised to try and capture the character of the buildings, without slavishly copying it (Fig. 44).

Inferior reinterpretations rarely work and not only look poor in comparison, but often undermine the older buildings they're seeking to emulate.

Similarly, avoid 'pick 'n' mix' pastiche where a building design uses a variety of 'traditional' features from different architectural periods rather than being true to a chosen architectural period and/or style.



Fig 44: Timekeepers Square, Salford by Buttress Architects. Georgian proportions and character without slavishly imitating the details.

## Facades

Facades are particularly important as they are the public face of the building. A key design consideration is the proportions of a building's facade. This is the solid-to-void (wall-to-openings) ratio and how the windows and doors are arranged. Façades should be well-balanced and well-proportioned with generously sized openings. Homes with small windows and/or relatively few windows appear austere and box-like. Larger windows and more frequent windows let more light into homes and also give a better outlook from within. Well-proportioned facades with generously sized windows are often a barometer of well-designed homes.

A well-designed facade can be the difference in how well a new building integrates with its context. A contemporary building of contrasting materials and architectural style can still be made to harmonise with its traditional neighbours through its facade. For example, floor to ceiling heights, window

proportions and orientation (portrait or landscape) can all be used to good effect. Done well this can ensure a strong visual link between buildings, even buildings of vastly contrasting age and style.

Façades should be coherent and visually appropriate. This means entrances should be easy to locate, regularly spaced, and have greater prominence over secondary entrances such as garage doors. Windows should be vertically and horizontally aligned, unless a strong, well-conceived architectural composition deliberately challenges this norm.

Windows and doors should be recessed at least a full brick depth behind the masonry to give visual definition. This does not apply to window types that project by design, for example, bays and oriels. Flush windows and doors must be justified as part of a deliberate and well-conceived architectural composition.

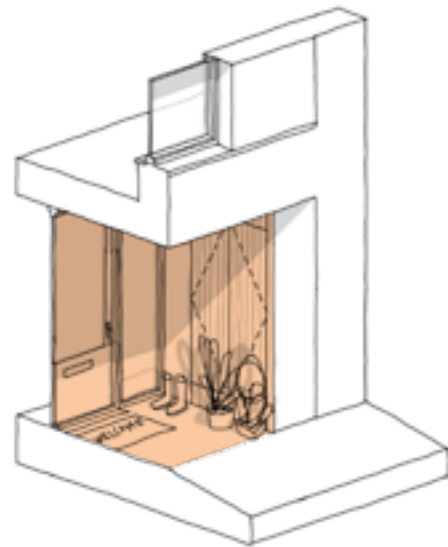

**Recessed entrance**  
Flooring, glazing, meter/bin cupboards, soffit, lighting, postal deliveries, external materials, and window cills considered.

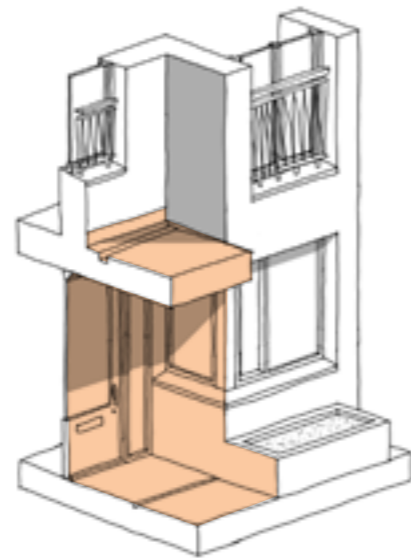

**Canopy Entrance**  
Flooring, seating, glazing, threshold, postal deliveries, security, soffits, lighting and internal finishes considered.

Fig 45 (a,b,c,d): A palette of well-designed and carefully detailed elements can give a development a coherent and distinctive character and give assurance about the quality of building at planning stage. These diagrams show detailed elements to be considered.

a) (L) Entrances to individual homes

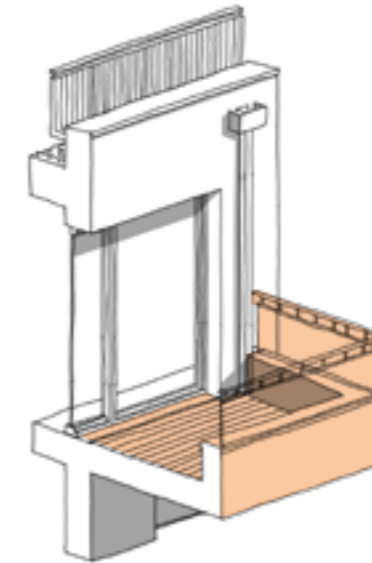

c) (R) Balconies and bay windows

**Projecting Balcony**  
Balustrade, window reveals, internal material, decking, soffits, coping, parapet considered.

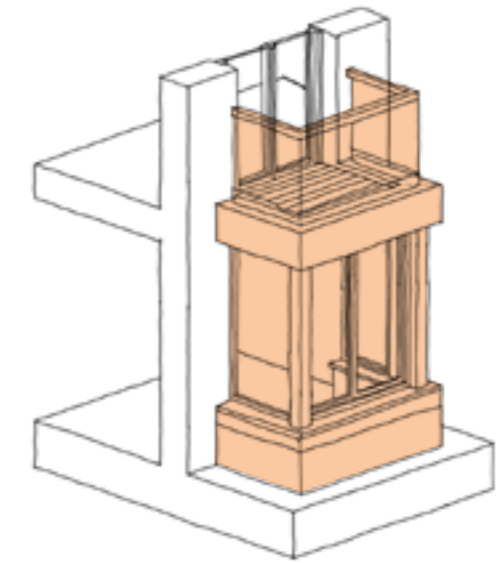

**Projecting Balcony**  
Balustrade, window reveals, internal material, decking, soffits, coping, parapet considered.

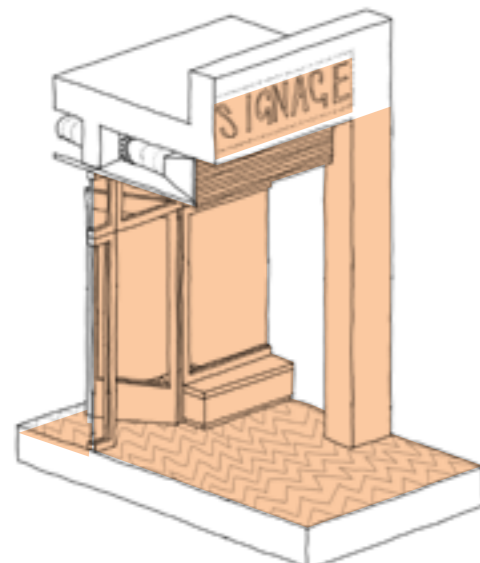

**Commercial Colonnade**  
Flooring, colonnade details, glazing, threshold, ventilation zone, soffits, lighting and signage zones considered.

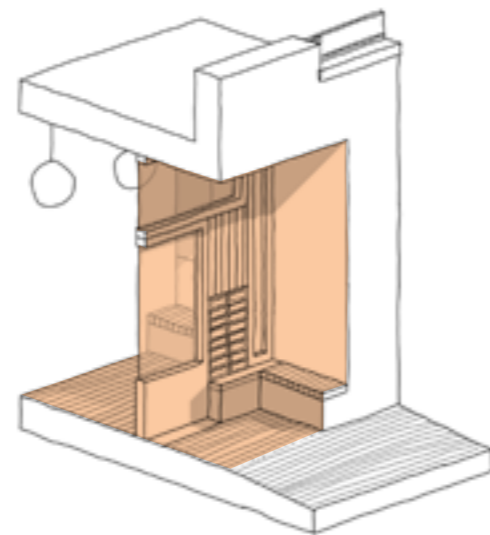

**Communal Entrance**  
Flooring, seating, glazing, threshold, postal deliveries, security, soffits, lighting, signage zones, and internal finishes considered.

b) (L) Entrances to apartment and mixed-use buildings

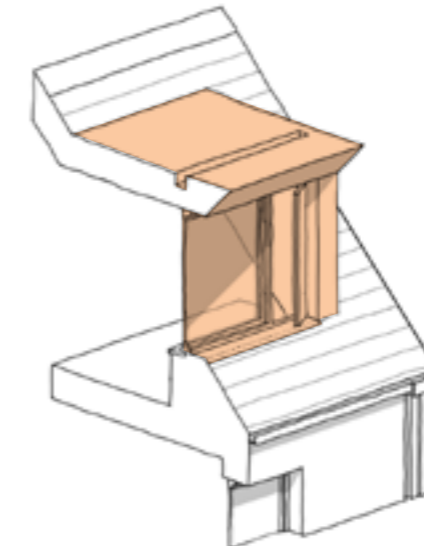

d) (R) Roof details

**Dormer, roof, ridge and rainwater goods** considered.

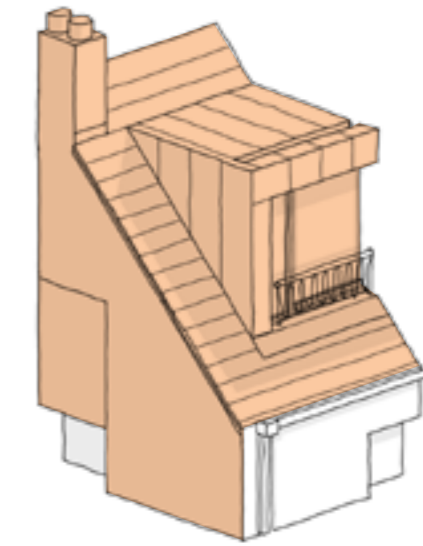

**Housing Dormer/Roof Dormer, gable wall, glazing, roof, ridge, chimney and rainwater goods** considered.



## Window design

Fig 46: St Chads, Thurrock Council, Essex by Bell Philips Architects.

A tight budget limited the team to UPVC windows. The detail used fixes the frame behind the brick reveal to reduce the typical bulky mass of UPVC windows. The windows are also colour matched to avoid the typical glossiness of white UPVC.

As a rule of thumb an acceptable window design is an honest design. This means modern contemporary buildings should have modern contemporary windows. Proposing a traditional style of window in a modern building seldom works, and is not an approach that will be supported.

In conservation areas, and other areas with a strong architectural character, new windows may seek to replicate a traditional style. Where this approach is being taken designers should propose genuine traditional windows such as genuine sliding sashes.

Corrupted historic styles such as mock sashes and degraded cross

windows are not acceptable in conservation areas, and areas with a strong architectural character.

As window and door systems have evolved UPVC/PVCU has joined the list of ubiquitous building materials and numerous residential proposals will now feature UPVC. Like with all materials the quality and design can vary and proposals should ensure windows and doors harmonise with the architectural approach of the buildings. Metal windows, and more recently coated aluminium is frequently used to good effect and suits clean, contemporary architecture.



Fig 47: Window reveal in plan. Example detail showing window reveal with frame set behind brick return to appear slimline.

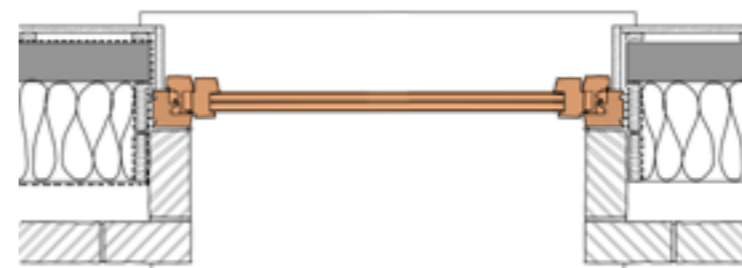

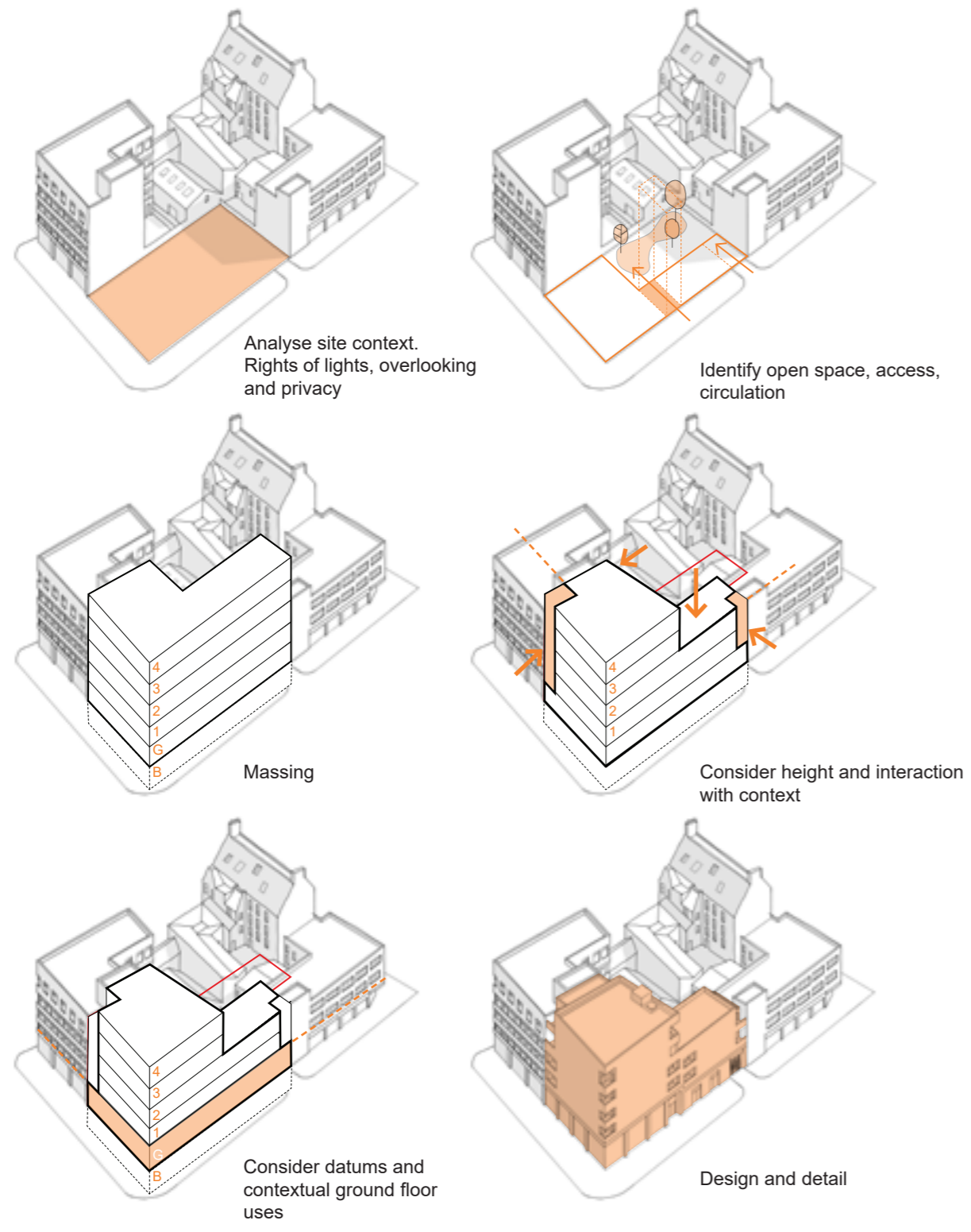

Fig 48: Illustrated sequence to explain how an infill development might respond to context. Massing and form should be the result of careful consideration of the rhythms, height, proportion and scale of the surrounding and adjoining buildings. Other complex factors such as rights of light, privacy and internal daylight levels may also shape the infill.

## Infilling

In small-scale and infill developments building height should generally respond to immediate context of adjoining and neighbouring buildings. How the volume of a building is arranged is known as massing. The massing of new buildings should mitigate against overshadowing, overlooking and over-enclosure of surrounding buildings.

Differences in height between proposed buildings and existing buildings can be made less prominent with set-backs or recess lines above a common eaves height. The overall bulk of a building and its impact in the street scene can also be broken down through varying materials and the introduction of external elements such as recessed

balconies, front gardens and boundary treatments.

It's not just about height. A successful design will also consider how the building's width fits into the street's horizontal rhythms and plot widths.



## Tall buildings

Proposals for tall buildings require additional design assessments as their impact is likely to be significant. This guidance purposefully offers no exact definition of a tall building as context is all important and will determine on an individual case basis.

Proposals for tall residential buildings may also come in the form of conversions of existing non-residential buildings. In such circumstances the guidance within this SPD also applies.

Visual impact is important as tall buildings are likely to be visible from further afield, and will become features in the city's skyline. Tall buildings also have a pronounced functional impact on their surroundings. This is because of the human activity they generate, parking and servicing, shadowing and other climatic considerations such as wind. Micro-climate should be carefully considered around the base of tall buildings, with

landscape and trees designed to reduce wind speeds.

Visual impact needs to be assessed from both the perspective of townscape setting, and in terms of long distance views. Although a building will have to be designed as a coherent whole, the reality is that in most cases the different parts of a tall building will be experienced separately, it can therefore be helpful to consider each part independently.

Close-up people will experience the bottom section - the base, podium, or plinth. It is recommended that lower floors are designed to integrate with adjacent buildings - a recess line, or shoulder, at the prevailing height of neighbouring buildings can help achieve this, as well as provide relief from the overall mass of the building. Design teams should consider how materials and human scaled detailing such as openings, entrances and sub-divisions fit in with the surrounding townscape.

Due to the city's flood risk, less vulnerable uses (i.e. non-residential) are better located at ground floor.

The middle section (bulk or shaft) is the largest section of the building and generally will use regular, uncomplicated floor plates for reasons of simplicity and cost. Design teams should consider how the mass and orientation of the middle section will influence issues such as shadow, loss of views and loss of privacy.

The top section must make a positive contribution to the city's skyline. Design teams should consider how the proposed building will be viewed from different directions and distances, as well as identifying existing views that will be affected/

interrupted. Roof top access and plant must not be neglected especially if visible from a distance. The design should consider whether it is visible as part of the silhouette, or concealed by a parapet.

Transitions between the three main parts of a tall building are best articulated programmatically or architecturally (change of use class or residential typology) rather than through simple changes in material that can look rudimentary.

Material choices are key. Avoid placing those that age and weather badly such as wood cladding and renders high up as these will be difficult to access and incur expensive maintenance regimes.

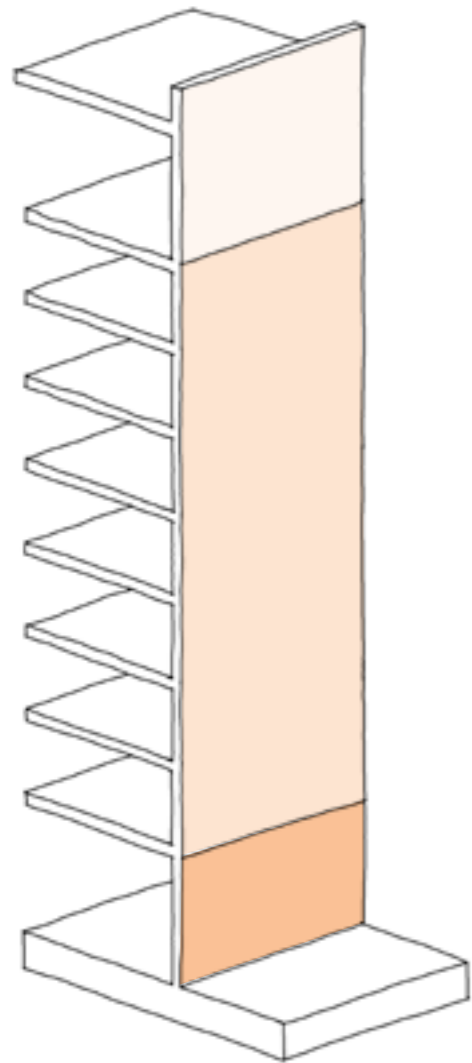

#### Roofscape

The termination of tall buildings contributes to the skyline of the City and wider perception of the building(s). Special attention should be given the articulation of this part of any tall building.

#### Mid-rise

The 'bulk' of most tall buildings would favour a degree of repetition and order to create a unified architecture.

#### Ground Floor(s)

Tall buildings are typically located in high population areas and should serve residents at the ground floor with commercial premises - offices or shops. Such uses are also less vulnerable to flood risk. The ground floor should enhance the public realm and contribute towards street life.

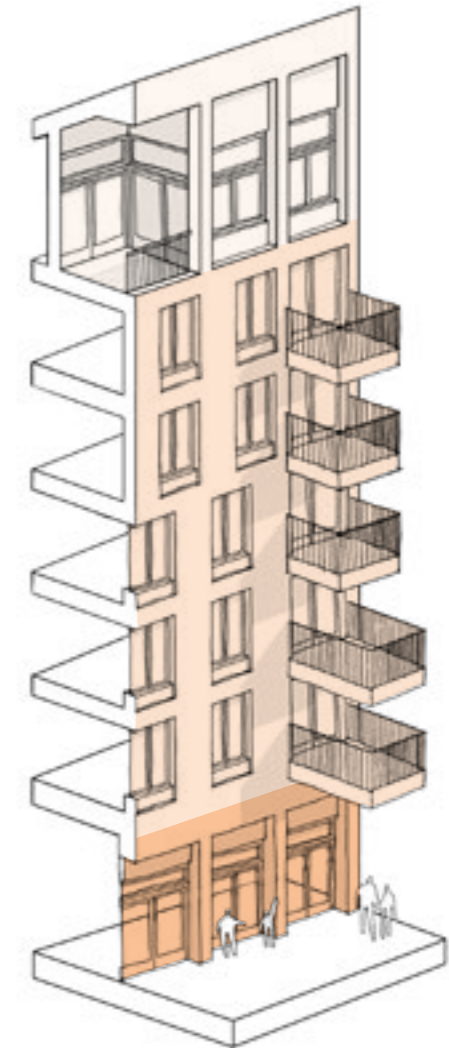
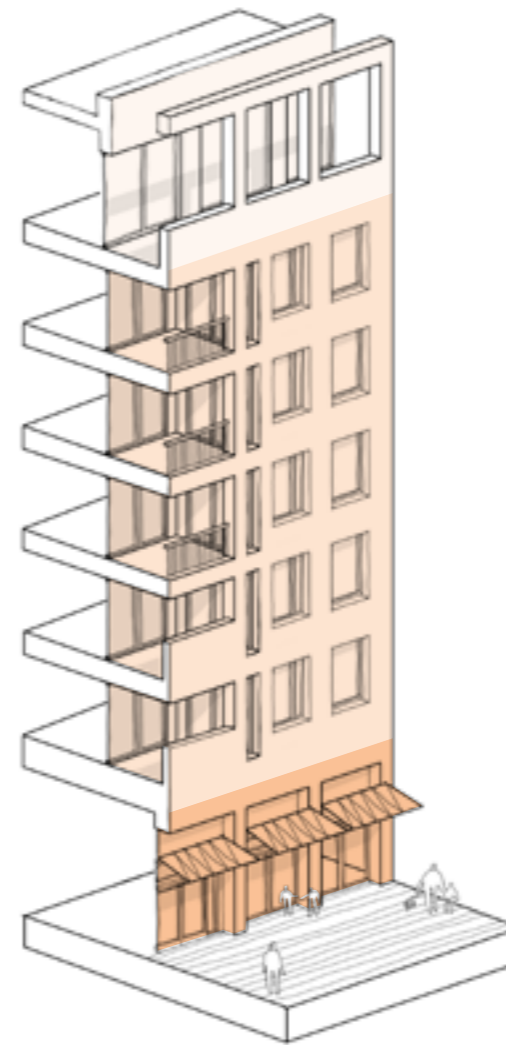
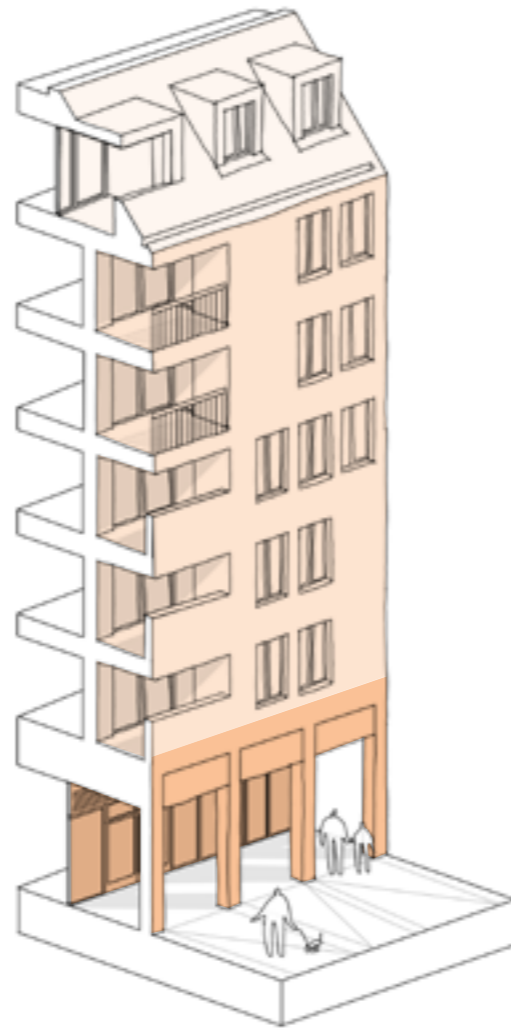

Fig 49: Tall buildings need to provide three key urban components - ground floor public realm, the main mass of the building, and roofscape.



## Material quality

Deciding the appropriate colour, texture and bond of materials are critical design choices in determining how well buildings will fit in with, or contrast with, their townscape surroundings. On a basic level materials affect how people feel about a building. With residential buildings this is very important because when people love their homes they are more likely to care for them, and take ownership of the areas that surround them.

Older homes, from Georgian, Victorian and Edwardian eras are buildings that have stood the test of time. In Hull, like most other parts of Britain, period properties are well regarded. It is a generally accepted view that local traditional materials such as brick, stone, slate, and clay tend to age well. This ageing, or patina, is a feature many people value, meaning they are often better cared for and last longer.

Modern varieties of traditional materials can sometimes lack the same softness and blending in over time, but they make up for this with a toughness and durability which people also value.

Quality, lifespan and maintenance requirements of materials is an important design consideration. Design teams should specify good quality and low maintenance materials for an attractive yet enduring appearance taking into account durability, water run-off and the ability to withstand weathering.

When specifying material choices it is important to also consider the type and tenure of buildings. In rented properties for instance, and/or in circumstances where the management and maintenance of buildings is outsourced, designers are advised to choose a limited range of robust, easy to clean, durable materials which will not deteriorate and tarnish quickly.

Simple design decisions such as avoiding downpipes on rendered elevations, avoiding render systems on north facing elevations, and ensuring the quality and capacity of elements such as guttering, downpipes, brackets, flashing, and window sills can avoid future problems with maintenance costs and appearance.

Fig 50: Submission of detailed sections are an opportunity to capture key materials such as boundary wall treatments, balustrades, window heads, cills and reveals, parapets, terraces and the incorporation of services and meter boxes.



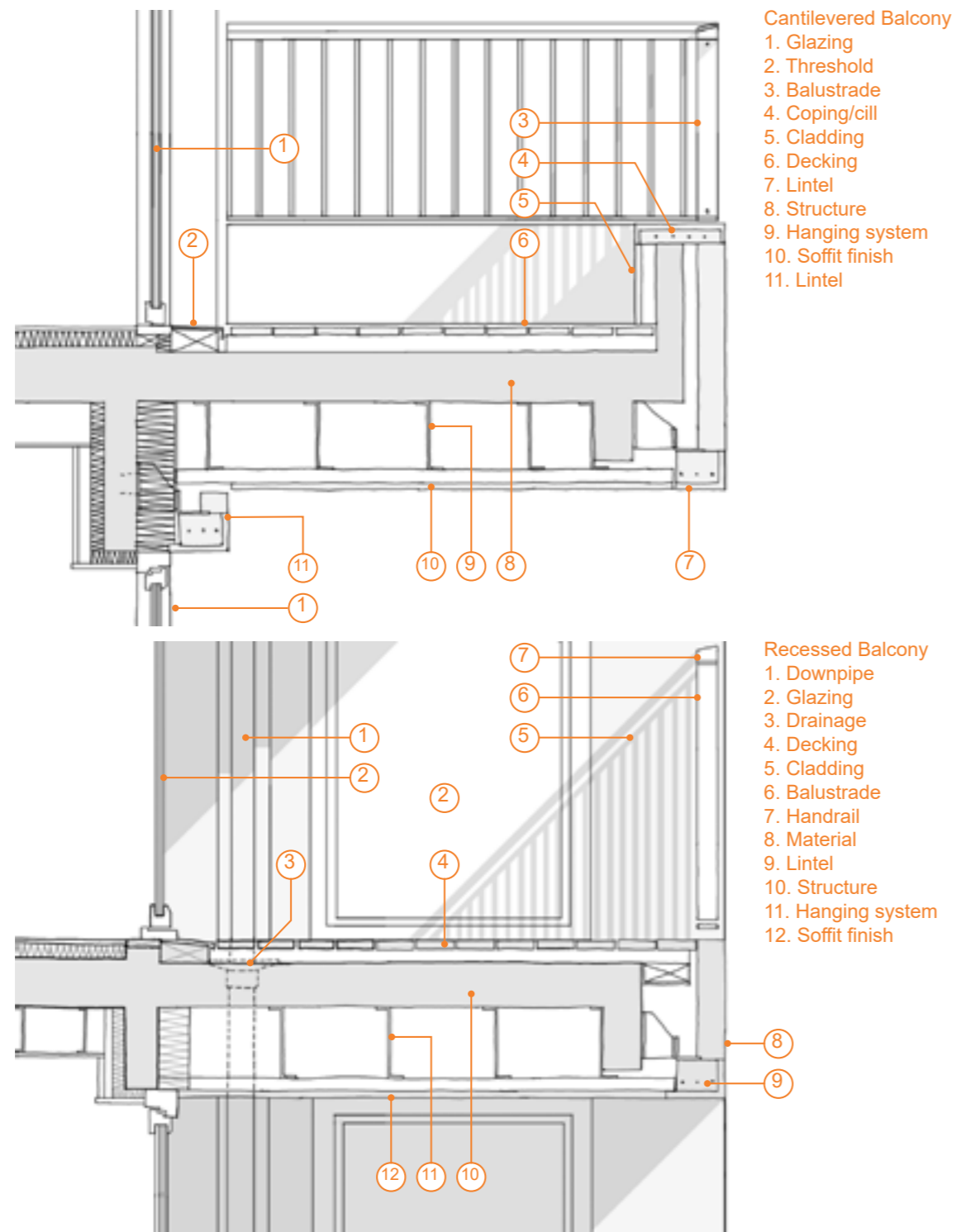

Fig 51: Two balcony drawings illustrating key details such as balustrade design and fixings, thresholds, floor finishes, soffit details and junctions between different facade materials.

Providing detail about repetitive elements such as balconies and bay windows helps to describe the architectural character of the proposal and gives a good sense of the quality of construction proposed.

## Detailing

A building's impact on people will be influenced significantly by detail or ornamentation. This goes beyond what the building is made of, and concerns how the various elements of a building's composition fit together and how they are viewed at close range and from afar.

Context will influence the extent and richness of architectural detailing in new buildings. New buildings should seldom seek to mimic detailing on nearby buildings, but should contain design elements which reflect the character of the area -elements such as doors, windows, and roofs are the details which often combine to create local character. Design teams should consider this guidance with that under 4.1 Design approaches.

It is not the intention of this guidance to discourage design teams from proposing architectural detailing within their building designs, but rather to encourage design teams to observe and absorb local

character and decide what is an appropriate and rational response in terms of the way they propose to detail and ornament new buildings. Design and Access Statements should explain the rationale behind these design decisions.

Modern design should not be used as an excuse for lack of thought about how buildings are detailed. Doing so results in dull, bland buildings.

Care and attention is always a requirement in the design of elementary details. This includes the depth of windows reveal, doors and eaves; the size and orientation of windows; the size and quality of sills and lintels; floor to ceiling heights; and choices regarding the materials and design of window frames, fascia, soffits, bargeboards, guttering, front doors, door frames, door steps, paving, balconies, outside lighting, bin stores and boundary treatments to name a few.



## Fabric first

Urban form has a significant impact on energy efficiency and cost to the end user. Much of the focus of improving the energy efficiency of new buildings is on the building fabric itself and energy technologies. Whilst this is important, the first design consideration should be the form that a new development takes. Form factor is about the compactness, or otherwise, of different building types and the associated heat loss. A bungalow for example will be much less efficient and therefore costly to heat than a mid-floor apartment, or mid terrace house.

New homes should be designed so they are capable of achieving thermal comfort without the need for mechanical space heating and cooling. This can be achieved through specifying good levels of insulation, air tight windows and doors, and avoiding thermal bridges.

Air-tight, well-insulated homes will prevent heat loss but should not compromise indoor air quality. Whilst it may sound obvious, the easiest way of ventilating a home is through opening windows and occupants will do so to suit their own comfort levels. An ability to cross ventilate a home is therefore important and generally

homes with only one opening window will not be supported. In some cases, particularly in apartment buildings, the number of openable windows may be restricted by the size of the apartment, and/or external conditions such as noise or poor air quality. In such circumstances trickle ventilation on individual windows, and stack ventilation serving the building can be used to regulate internal air temperature and bring fresh air in, and move stale air out.

Fabric first principles work equally well in reverse and protect buildings from overheating in warm weather. Design teams should avoid excessive solar heat gain by incorporating design features such as high levels of thermal mass in the building's fabric to absorb, store and slowly release heat throughout the day and night. Using smart glazing systems in south facing windows, and installing reflective and insulating window blinds will also help protect homes from overheating. Overhanging eaves on south facing elevations will shade windows and walls. Planting, especially deciduous trees, can help create relief from the sun in summer, without blocking out winter sun.

Fig 52: Form factor overview of different urban arrangements. Detached and semi-detached typologies with complicated forms perform the least efficiently, whilst terraced and apartment typologies are more efficient. Form factor is calculated as the ratio of thermal envelope surface area divided by the treated floor area (TFA).

Source: Passivhaus primer: Designer's guide - A guide for the design team and local authorities, BRE, (2016)

Fig 53: More efficient form factors provide kWh/Yr savings. This provides a significant energy reduction and cost saving to the end user.

Source: 'Overheating in homes – the big picture', Zero Carbon Hub (2015)

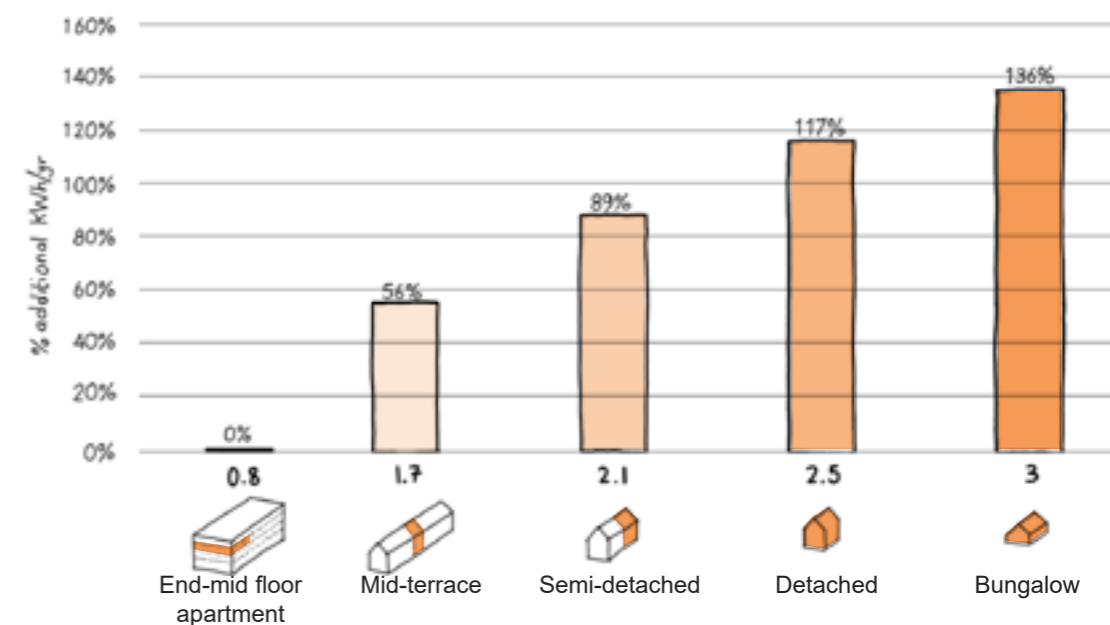
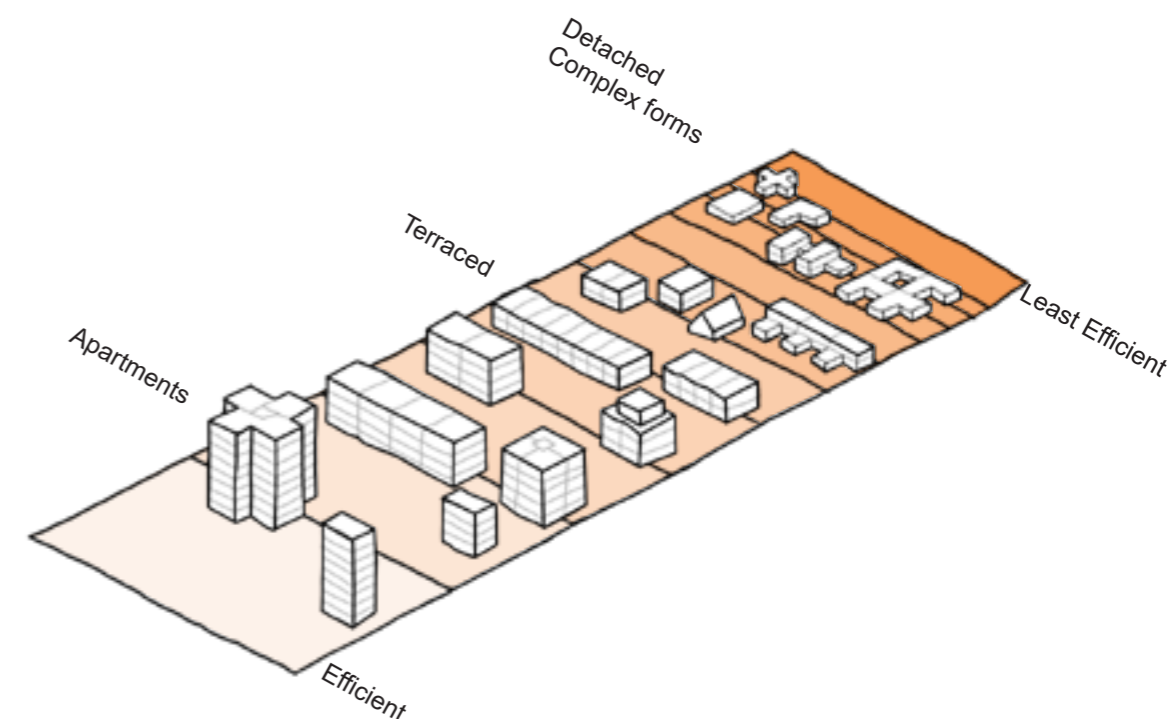
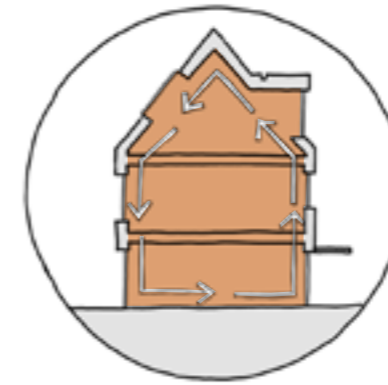

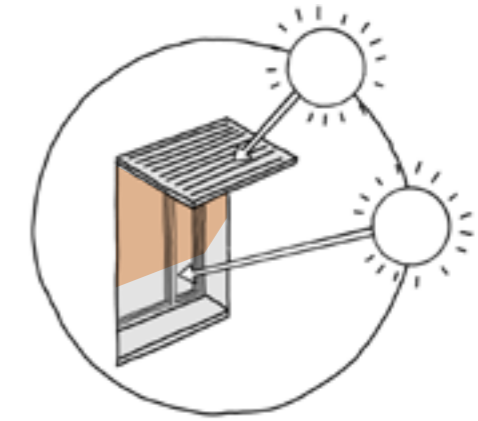



Fig 54: Goldsmith Street, Norwich by Mikhail Riches Architects for Norwich City Council. The development achieves Passivhaus house standards using fabric first principles including solar shading to reduce heat gain to some windows. Awarded the RIBA Stirling Prize 2019.



Airtightness



Solar Shading

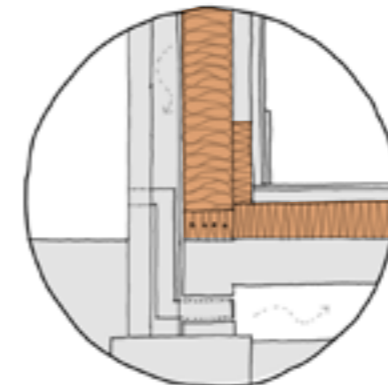

Reduce thermal bridging  
Consider Enhanced Construction Details (ECDs)



Ventilate

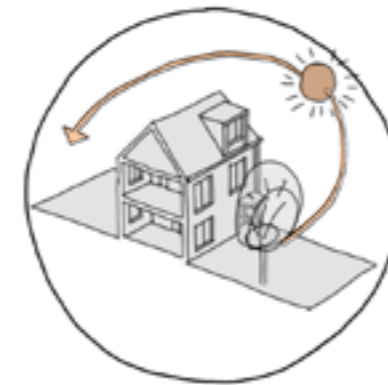

Orientation and landscape

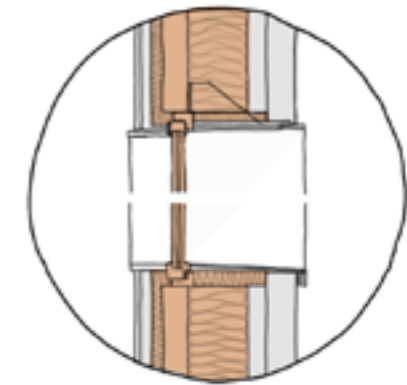

High specification windows and levels of insulation

Fig 55: Key principles of a fabric first approach.



Hull is ready for a new generation of house designs to emerge which ensure the safety of residents inside the home, and the resilience of the building itself. In some respects apartment buildings offer one solution to flood risk by elevating homes above potential flood waters. However, given the means, it seems that many people prefer to live in dwelling houses, and the traditional notion of a house is as strong as ever.

This means that both housing and people's expectations must adapt as our climate continues to change. This means houses designed with built-in resilience, and less vulnerable uses at ground floor level such as integral parking, and second bathrooms designed as wet rooms.

Traditional ground floor living space, bed spaces and kitchens could be elevated to first floors and above. This may have an impact on streets and the needs for animated frontages and so will require thoughtful design responses.

Popular two-storey palatial forms may need to be adapted into taller, leaner contemporary forms over three floors with integral private outdoor amenity space designed into upper levels and roof spaces.

Equitable access will require intelligent solutions and people's perception of flood risk and 'Living With Water' will need exploring and challenging through new housing design.

**Fig 56: Houses**  
In addition to internal layouts which allow for partial flooding, maximising areas of soft landscaping on and around buildings, e.g. driveways, gardens and roofs could have a significant cumulative impact on resilience at the neighbourhood level.

**Fig 57: Apartments**  
Apartment buildings present many opportunities for water resilience. In addition to raised ground floors and sacrificial basements, there are opportunities for collective strategies such as attenuation ponds, tree planting and grey-water recycling.

#### Housing

1. Elevated floor levels
2. Utilities/parking at ground floor
3. Attenuation crates
4. Soft planting
5. Trees
6. Permeable gardens
7. Attenuation ponds
8. Roof terraces
9. On-site energy generation
10. Water Butt
11. Intensive green roofs

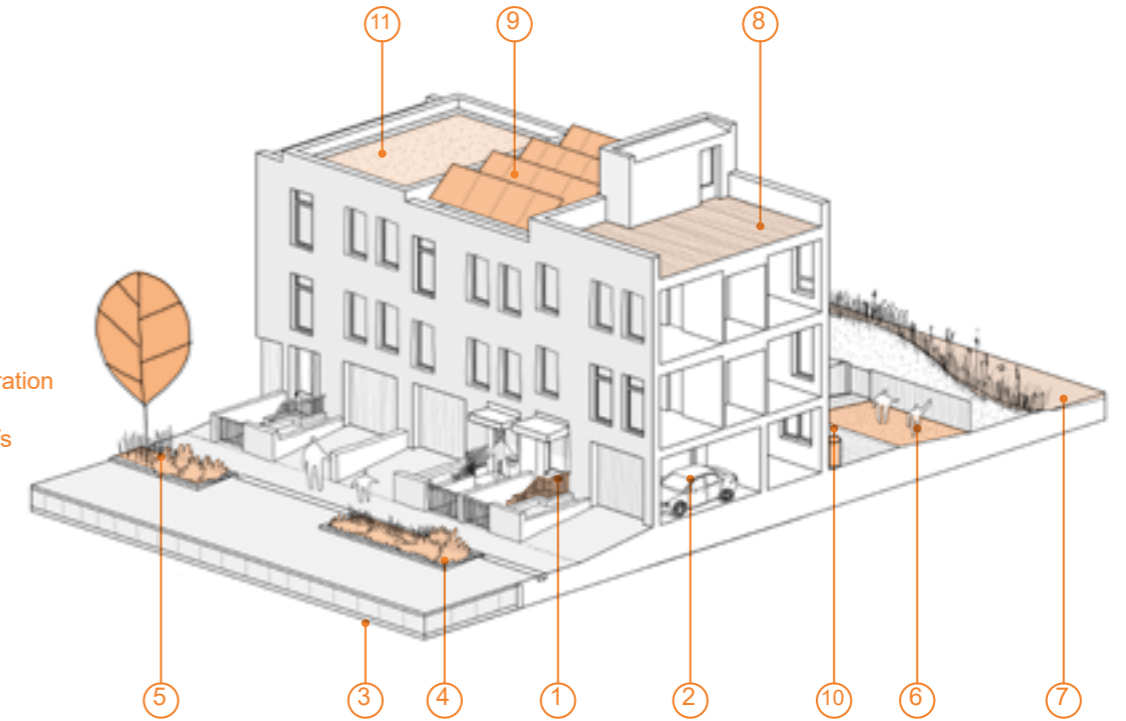

#### Apartments

1. Elevated ground floor
2. Attenuation crates
3. Attenuation tanks
4. Rainwater collection/recycling
5. Trees
6. On-site energy generation
7. Green/brown roof
8. Parking as potential attenuation tank
9. Soft landscape

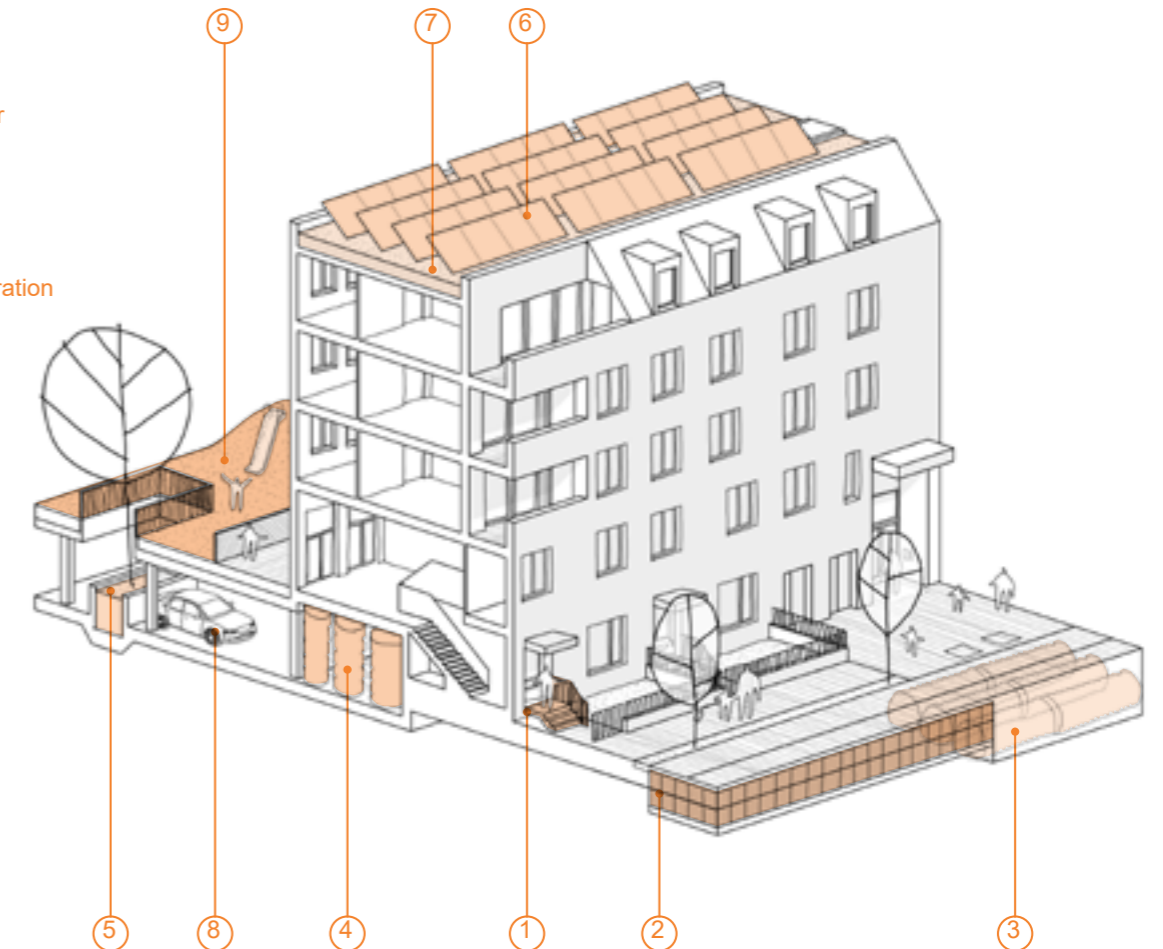







## Modular housing

4.11

Modular housing built using modern methods of construction (MMC) offer benefits such as reducing on-site waste, streamlined construction methods, reduced ecological impacts and affordability. They also offer something different in terms of materiality and appearance. In appropriate locations this form of housing development can provide an important injection of fresh design ideas into the housing mix.”

MMC can speed up the process, make challenging sites more

viable, and provide adaptable homes capable of amendments in response to changing market conditions, climate, and consumer preference.

As with all residential design, but perhaps even more so with MMC approaches, pre-application discussion and decisions on design need to take place early and be carried through to production and construction, as minor revisions late in the process may not be easy.

Fig 60: Hugh Webster Place, Hull by Hodson Architects. Modular housing systems will be important in delivering housing targets. Like all good new housing, the urbanism, architecture and landscape should be contextual to the site and not result in homogenised typologies or generic responses to site.



## Living space inside and out

### Daylight and sunlight

Getting plenty of daylight into homes may have benefits to people's health and well-being, and it certainly reduces the need for artificial lighting. At the same time new development should not cause an unacceptable loss of daylight to habitable rooms of existing neighbouring properties and should not cause an unacceptable loss of sunlight to neighbouring properties and gardens.

There are many ways to get more natural light into buildings including carefully planning a building's orientation, and the position, form and massing of buildings in relation to each other. A priority for all new residential development should be trying to get as much natural light as possible into dwellings and outdoor spaces.

Daylight can usually penetrate into a room to a depth of twice the window height. Therefore generously sized windows to habitable areas are strongly encouraged, particularly to living spaces. Floor to ceiling heights should facilitate this and design teams are strongly encouraged to exceed minimum height requirements of 2.3 metres. Minimum standards impede good design and in a majority of cases exceeding this requirement will

result in more attractive, well-proportioned homes.

Outlook is an important planning consideration and design teams should be wary of the quality of outlook from buildings, in particular from windows to living spaces. Negative outlooks such as those into service yards, or narrow overly-enclosed areas should be avoided. Rather outlooks should include views of the sky, and views that connect inhabitants with their living environments such as gardens, courtyards, streets, and open spaces.

Design teams can increase natural light by maximising the number of windows receiving direct sunlight, and considering large feature windows especially in living spaces. A knock-on benefit of this generosity will be attractive, sought-after homes which remain durable over time.

In the majority of cases dual aspect homes will be expected. Single aspect homes are generally discouraged, whilst single aspect homes which face broadly north are strongly discouraged. Achieving daylight within internal corridors is desirable in reducing the reliance on artificial light.

Fig 61: Dual aspect orientation should be the default approach for all new housing as it provides a good distribution of natural light and allows residents flexibility to open windows on the quieter side of the home. This is easily achieved in terraced or semi-detached layouts.



Fig 62: Careful consideration of internal circulation and access in apartment buildings is required to ensure a good quality of natural daylight internally. Dual aspect should be default.



Fig 63: A typical one bed apartment orientated with large windows to living areas whilst bedrooms and kitchens have smaller windows. Single aspect apartments are at a higher risk of overheating and should be avoided.

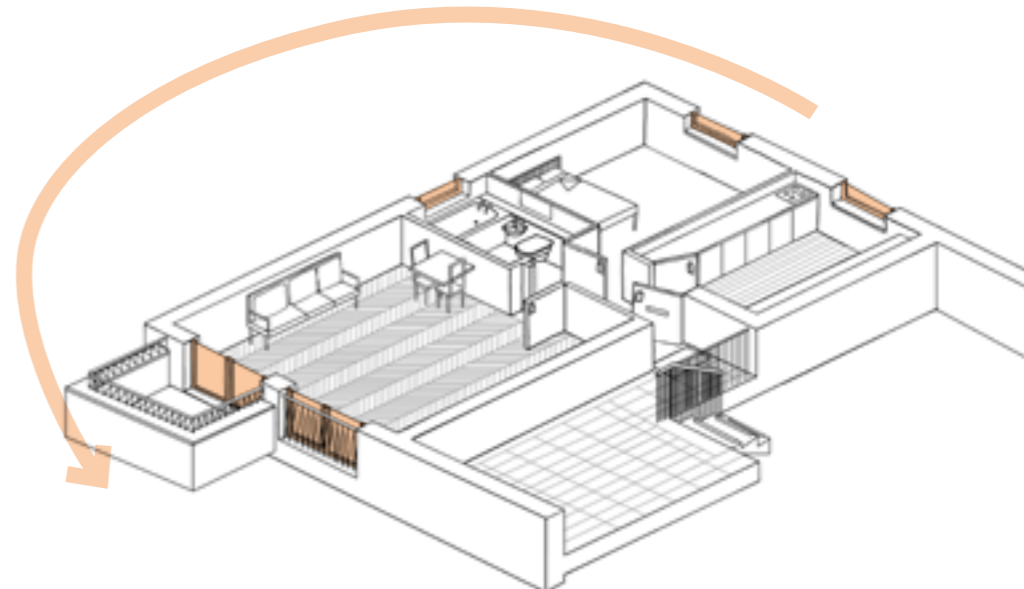



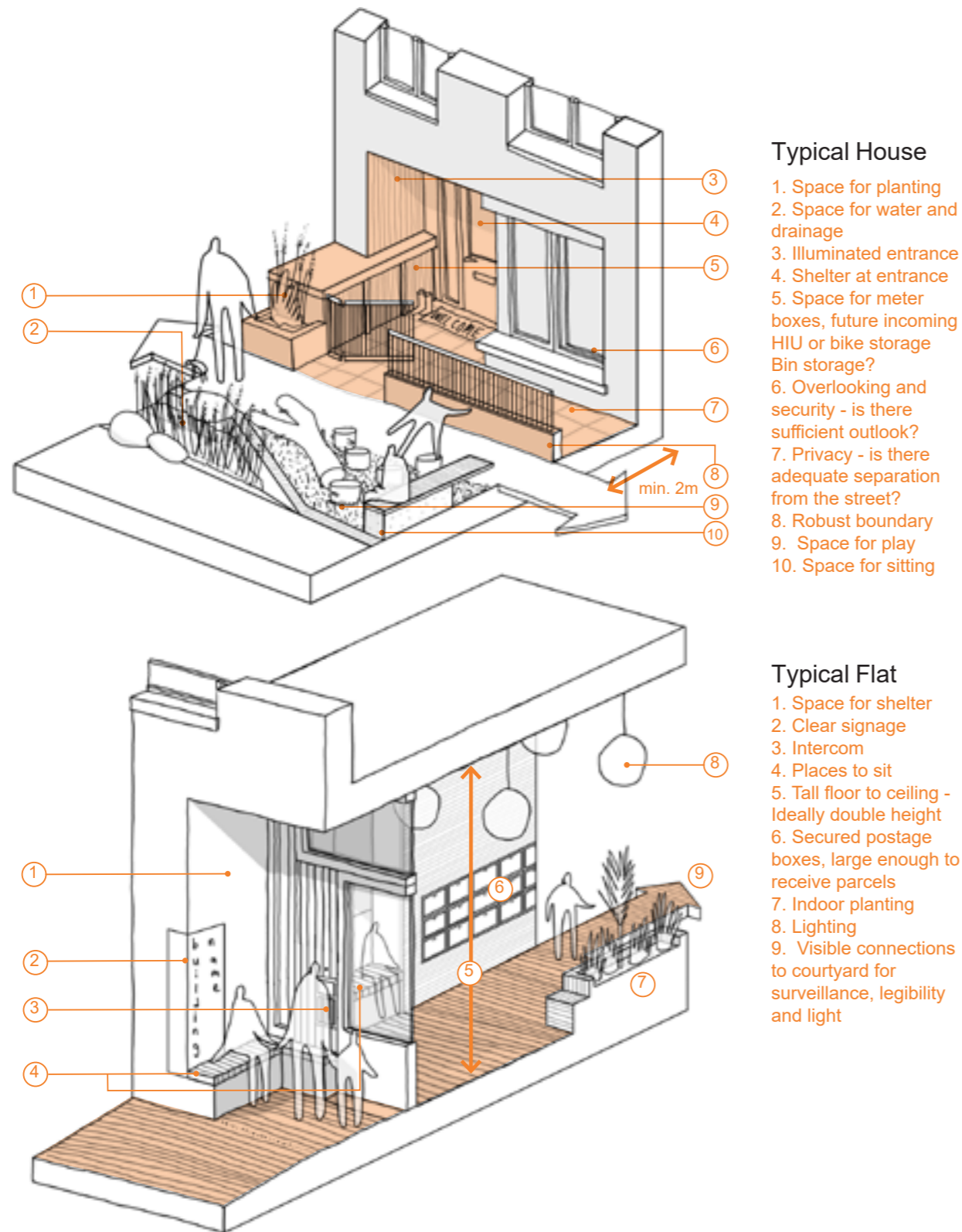

Fig 64: Thresholds tackle a variety of issues from public/private boundaries and privacy to more pragmatic issues such as bin/bike storage or location of meter boxes. Careful consideration of these issues should be given from the outset of the design.

## Thresholds

Thresholds are an often overlooked design detail yet they are the physical link between a resident's private domain and the street outside. A semi-private space between the front of the dwelling and the public street, thresholds should aim to protect the privacy of the home, but connect to the world outside.

In the case of larger house types front gardens offer the largest and most attractive threshold type and should be included where appropriate. On narrower streets with a stronger sense of enclosure properties will benefit from a shallow set back in the region of 1.5 to 3 metres creating a physical and visual break to provide additional privacy and allow residents to take ownership and advantage of these spaces with window boxes, seating, pots and planters etc.

Porches, whether recessed or projecting, provide shelter when people have to stop to find their keys, or greet a visitor without having to invite them inside. They also provide an opportunity to light the threshold and in doing so aid access and security.

Design teams should consider the small details such as how meter boxes and other clutter can be removed from facades, and bins removed from frontages by designing integrated storage into the fabric of buildings. Another small detail to consider is the position of letterboxes and ensuring these are easily accessible i.e. not too high for a wheelchair user and not too low meaning people have to stoop low to the ground.

In apartment buildings thresholds are important inside and out. Lighting should emphasise entrances and lobbies, making them safe and inviting. Approaches to buildings and pathways should be similarly well-lit and overlooked by windows and balconies.

## Private amenity space

Residential developments should make a clear and obvious distinction between public fronts and private backs. Layouts should follow a traditional arrangement with backs adjoining the backs of other homes, and fronts facing one another across the street. In this way new homes should face the street (or other public space) and in most cases this will mean the primary access - the front door - is from the street. Internal layouts should support this design principle by featuring large windows in the front elevation and ensuring rooms with smaller or obscured windows are placed towards the side and rear of buildings.

Arranging new developments in this way will also aid security and design teams should consider how physical protection can be enhanced through specifying strong and secure doors and window systems. The principles of Secured by Design are now found within Building Regulations Part Q.

Balconies and terraces can provide attractive and welcome private amenity space. They should be large enough to fit the furniture needed for the maximum number of intended residents to sit comfortably.

Fully or partially recessed patios, terraces and/or balconies can provide well-integrated outdoor spaces which enjoy protection from the elements. Everyone, and especially elderly people, or people living in care environments, benefit greatly from outdoor space which is not reliant on dry weather and is readily accessible from their living spaces.

It is reasonable for privacy expectations to vary depending on the location of development. For instance expectations will be greater in more suburban locations compared to the city centre where buildings and outdoor amenity spaces can be relatively close knit.

Design solutions are encouraged where they enable developments which may otherwise be difficult due to tight spacing, and concerns about home-to-home views. Through careful design such as ensuring living spaces are not arranged opposite bedrooms; and features such as recessed balconies and terraces, angled bays, louvres, and deep planter beds outside ground floor windows, it is often possible to ensure appropriate levels of privacy in tight infill sites.

Fig 65: Private amenity space is an essential part of the enjoyment of homes. It can come in different forms, from recessed balconies which provide all-year round usage, to private rear gardens with integrated storage.

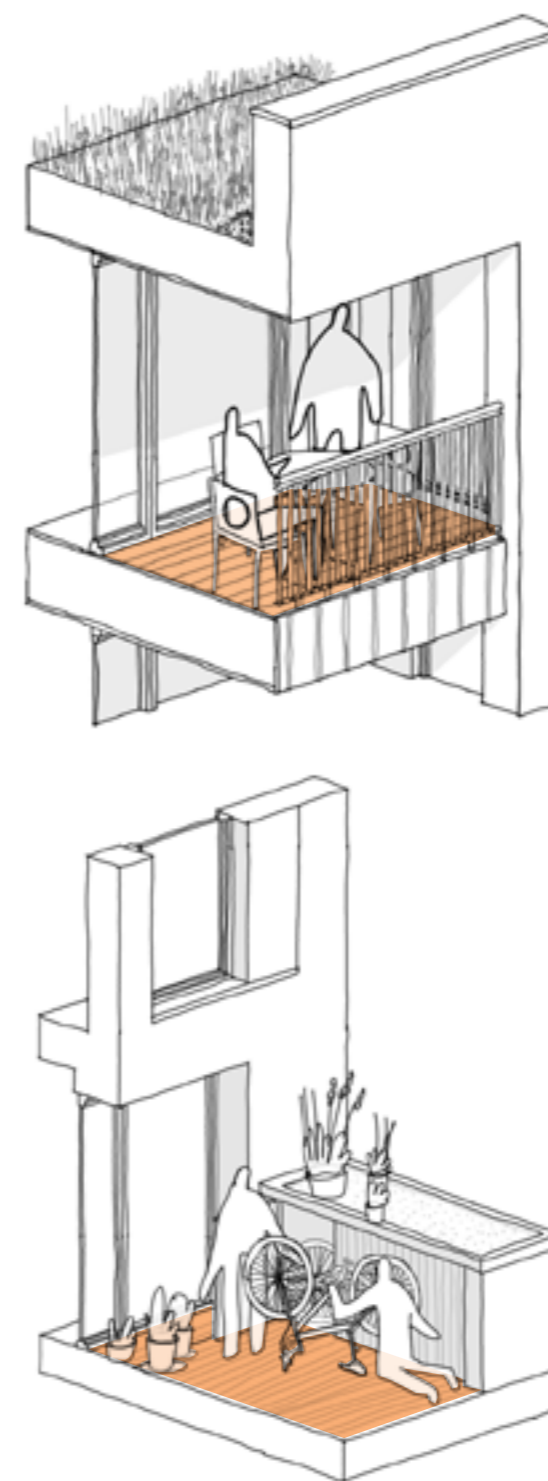



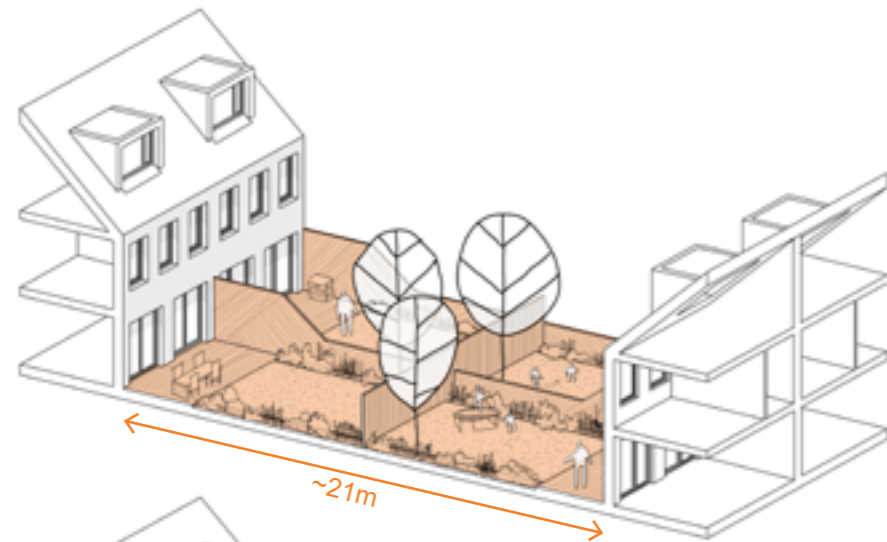

Fig 66: Conventional ratio of back to back.

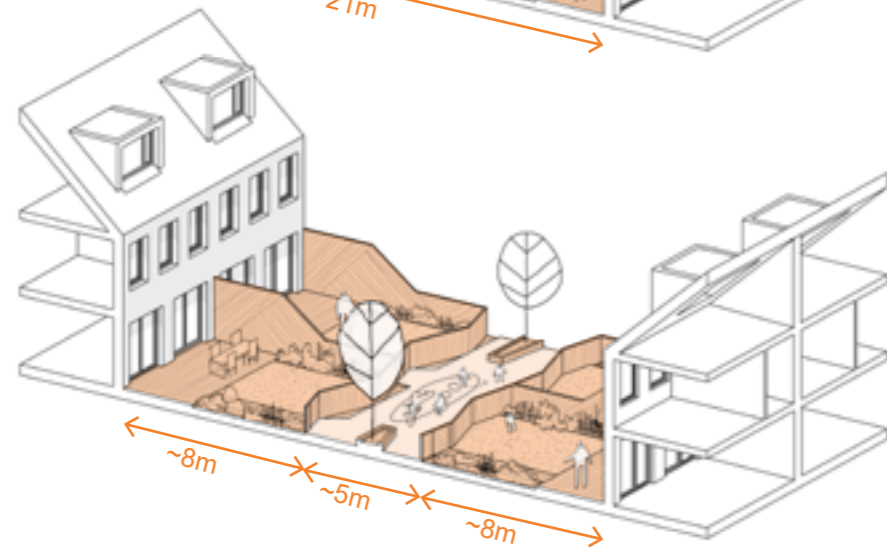

Fig 67: Conventional ratio of back to back with shared communal space in-between to foster neighbourliness, community and provide safe places to play.

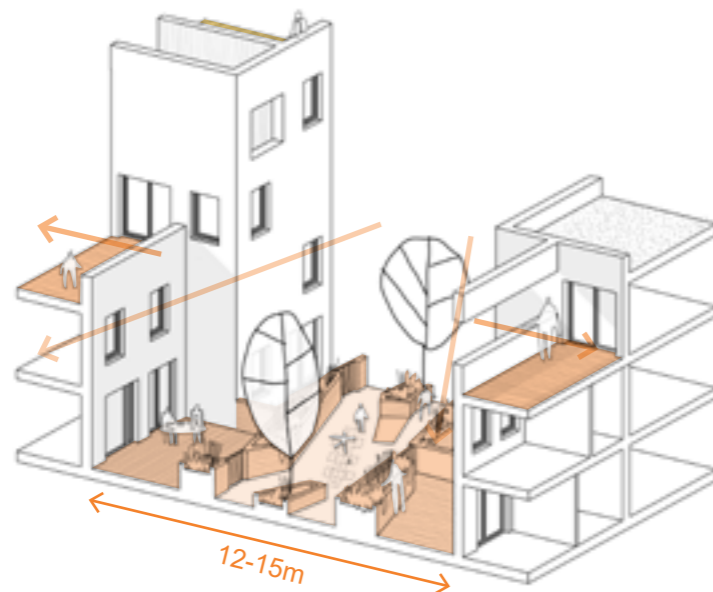

Fig 68: Non-conventional distances will require implementing strategies to mitigating impact on residents privacy. Consider splayed or offset façades, use of roof terraces (to mitigate against smaller gardens), offset windows and landscaping to manage overlooking.

## Space around homes

Plot coverage ratios, or the proportional relationship between the area of the plot and the built footprint of a property, will vary according to location and context. In order to prevent sites being over-developed proposals should leave sufficient open space around a new dwelling for outdoor activity and access. For detached and semi-detached dwellings, suitable for family housing, the proportion of plot area to building footprint should generally be greater than 60:40 to allow for decent sized gardens for children to play. For terraced houses and townhouses the ratio is likely to be closer or with a higher proportion of built footprint. Bfl 12 recommends an average ratio of 50:50. Garden sizes do not have to be uniform across a development.

In keeping with the principles of this guidance, separation distances between homes should be determined by design teams and informed by both context appraisals and the intended townscape character of the proposed development.

Design teams should ensure new properties are sufficiently and justifiably spaced and explain this within their application. The minimum dimensions set out in table 2 (below) are designed to mitigate against loss of privacy and overlooking, loss of light and overshadowing, over-dominance and enclosure.

Deviations from these guidelines will require justification and will only be deemed satisfactory where it is demonstrated that residential and environmental amenity will not suffer for either the proposed or existing buildings.

Aspect	Distance
Front to front facing a highway *	To be determined case by case
Back to back	21m
Front to side **	18m

Semi-detached and detached	
Side to side	2.5m +1m for a driveway +2.5m for adjacent driveways
Side to boundary	1m

\*See guidance on *Enclosure* and *Residential Streets for All*

\*\*Only where side elevation is of acceptable design

Table 2: Guidance on minimum distances between dwellings.

## Houses in multiple occupancy

---

All guidance in this SPD applies equally to Houses in Multiple Occupancy (HMOs). The nature of the living arrangements within this housing typology requires specific design considerations. Basic features such as providing shared internal and outdoor amenity space for residents should not be overlooked because a building is proposed as a HMO.

When designing internal layouts care should be taken to mitigate potential disturbance between rooms. Each private room should be accessible directly from communal circulation areas and there should be sufficient communal facilities such as bathrooms and WCs for the intended number of occupants.

Certain features need to be designed into HMOs such as integral locking systems on bedroom, WC and bathroom doors; intercoms; sufficient electrical sockets in bedrooms; and sufficient built-in storage.

Walls, floors and ceilings in Kitchens, WCs and bathrooms should be finished with smooth,

impervious linings that are easily cleaned, maintained and periodically replaced.

Poorly managed HMOs can adversely affect the character and appearance of the street and area. To avoid this HMO operators should have a maintenance plan for the upkeep of the exterior of the property, including the garden, boundary and amenity areas. A common failing leading to the untidy appearance of HMOs is insufficient provision for refuse storage and disposal both inside and outside the home.

Providing residents with sufficient facilities to wash and dry their clothes (preferably both inside and outside) is important to the comfort and amenity of the residents and will also avoid issues such as damp arising from multiple people having to frequently dry their clothes on bedroom radiators.





Figure 69: Hgh  
Webster Place, Hull  
by Hodson Architects

## References and further reading

---

[Approved Document M : Access to and use of buildings, Ministry for Housing, Communities and Local Government](#)

[Building For Life 12](#)

The Concise Townscape, Gordon Cullen, Architectural Press (1961)

[Design Requirements for Surface Water Attenuation Management Assets, Yorkshire Water, \(2017\)](#)

The Environmental Design Handbook, Sofie Pelsmakers, (2012)

[HEYwoods](#)

The Housing Design Handbook; A Good Guide to Practice 2nd Edition, David Levitt and Jo McCafferty, Routledge (2018)

[Hull City Centre Parking Strategy Supplementary Planning Guidance, Hull City Council, \(2018\)](#)

[Hull Local Plan 2016-32, Hull City Council, \(2016\)](#)

[Implications of the Cole Report: Restoring confidence - A need for a focus on quality, Professor John Cole, \(2018\)](#)

[Manual for Streets, Department for Transport, \(2007\)](#)

[National Planning Policy Framework, \(2018\)](#)

[Overheating in Homes: The Big Picture , Zero Carbon Homes, \(2008\)](#)

Planning for SuDS – making it happen, Dickie, S, McKay, G, Ions, L, Shaffer, P, CIRIA, (2010)

[Protecting existing and providing new open space Supplementary Planning Guidance, Hull City Council, \(2016\)](#)

[Supplementary Planning Document 10: Trees, Hull City Council, \(2019\)](#)

[Secured by Design](#)

[Security in dwellings: Approved Document Q, Ministry for Housing, Communities and Local Government](#)

Soft City: Building Density for Everyday Life, David Sim, Island Press, (2019)

[Strategic Flood Risk Assessment, Hull City Council, \(2016\)](#)

[Supplementary Planning Document: Living with Water - Approach to Surface Water Drainage, \(2019\)](#)

[SUSDrain](#)

## Figures

---

All illustrations and drawings remain the copyright of Harper Perry and Hull City Council with exception of the following photography which is the copyright of the following photographers.

Cover: Harper Perry Architects

Fig 3, 14, 15, 23, 58: Copyright Rob Beardsworth

Fig 17: Copyright Jill Tate

Fig 18, 24: Copyright Harper Perry Architects

Fig 25, 41: Copyright David Butler

Fig 29, 46: Copyright Kilian O'Sullivan

Fig 44: Copyright Daniel Hopkinson

Fig 54: Copyright Tim Crocker

Fig 59 - A Space Architects

Fig 60, 69: Copyright Gavin Webster